

LEARNING OBJECTIVES

After completing this lesson, you will be able to:

1. Create a new Text Style
2. Change an existing Text Style
3. Delete a Text Style
4. Select a Point Style
5. Divide an object into specified number of segments
6. Divide an object to a specified measurement

LESSON 25

CREATING NEW TEXT STYLES

AutoCAD provides you with two preset Text Styles named "Standard" and "Annotative". (Annotative will be discussed in Lesson 27)
You may want to create a new text style with a different font and effects.
The following illustrates how to create a new text style.

1. Select the TEXT STYLE command using one of the following:

Ribbon = Annotate tab / Text panel / 
or
Keyboard = ST <enter>

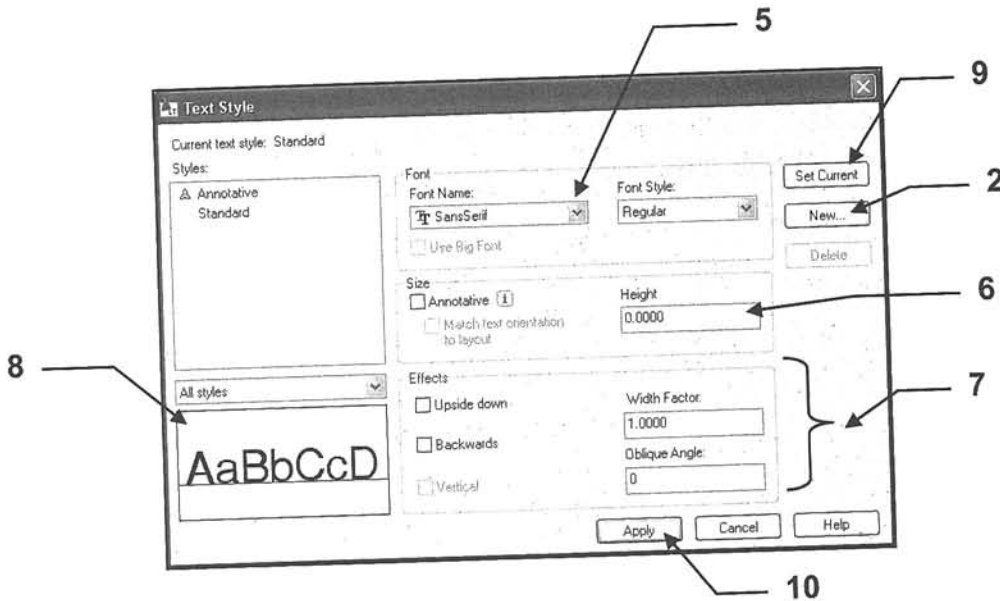
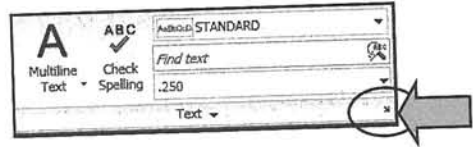

2. Select the **NEW** button.

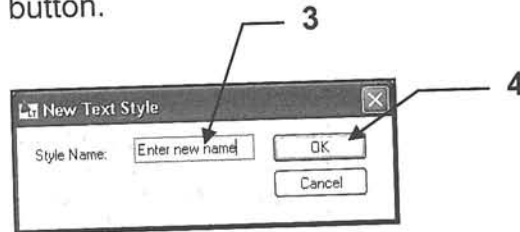

3. Type the new style name in **STYLE NAME** box.
Styles names can have a maximum of 31 characters, including letters, numbers, dashes, underlines and dollar signs. You can use Upper or Lower case.
4. Select the **OK** button.
5. Select the **FONT**.
6. Enter the value of the Height.
Note: If the value is 0, AutoCAD will always prompt you for a height. If you enter a number the new text style will have a fixed height and AutoCAD will not prompt you for the height.

CREATING NEW TEXT STYLES....continued

7. Assign **EFFECTS**.

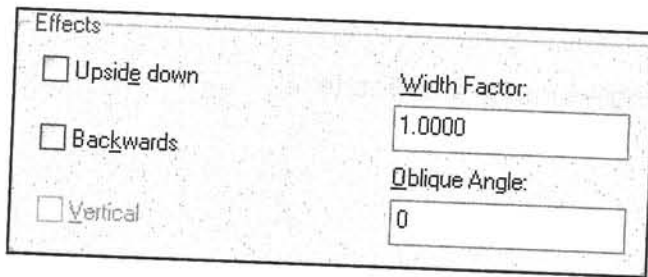

Effects

Upside down

Backwards

Vertical

Width Factor: 1.0000

Oblique Angle: 0

UPSIDE-DOWN

Each letter will be created upside-down in the order in which it was typed. (Note: this is different from rotating text 180 degrees.)

BACKWARDS

The letters will be created backwards as typed.

VERTICAL

Each letter will be inserted directly under the other. Only **.shx** fonts can be used. **VERTICAL** text will not display in the **PREVIEW** box.

OBLIQUE ANGLE

Creates letter with a slant, like italic. An angle of 0 creates a vertical letter. A positive angle will slant the letter forward. A negative angle will slant the letter backward.

WIDTH FACTOR

This effect compresses or extends the width of each character. A value less than 1 compresses each character. A value greater than 1 extends each character.

8. The **PREVIEW** box displays the text with the selected settings

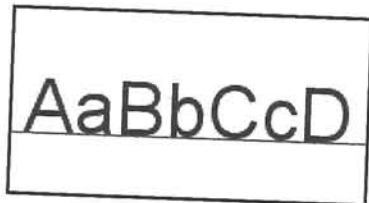

9. Select the **Set Current** button.

10. Select the **Apply** or **Close** button

HOW TO SELECT A TEXT STYLE

After you have created Text Styles you will want to use them. You must select the Text Style before you use it.

Below are the methods when using Single Line or Multiline text.

Single Line Text

Select the style before selecting Single Line Text command.

1. Select the **Annotate** tab.
2. Using the Text panel, select the style down arrow ▼
3. Select the Text Style

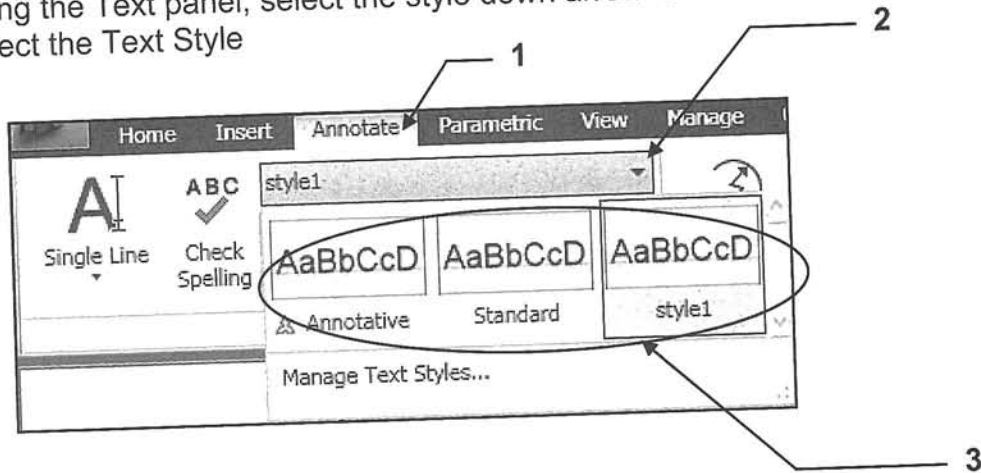

Multiline Text

1. Select **Multiline Text** and place the **first corner** and **opposite corner**.
2. Find the **Style** panel and scroll through the text styles available using the up and down arrows.

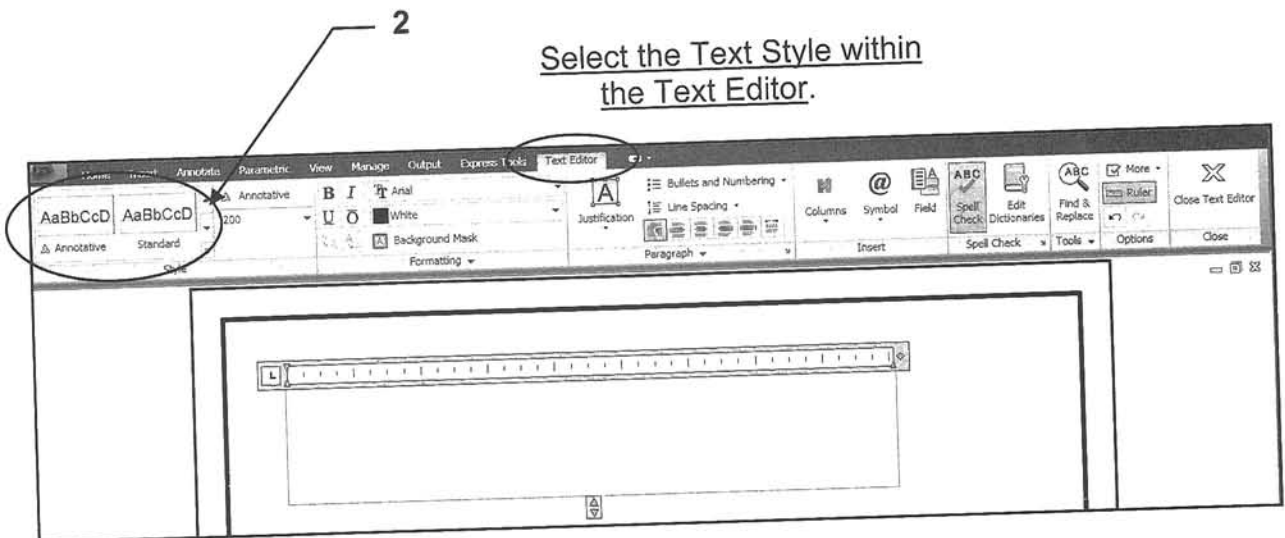

DELETE A TEXT STYLE

1. Select the **TEXT STYLE** command using one of the following:

Ribbon = Annotate tab / Text panel / ↘
or
Keyboard = ST <enter>

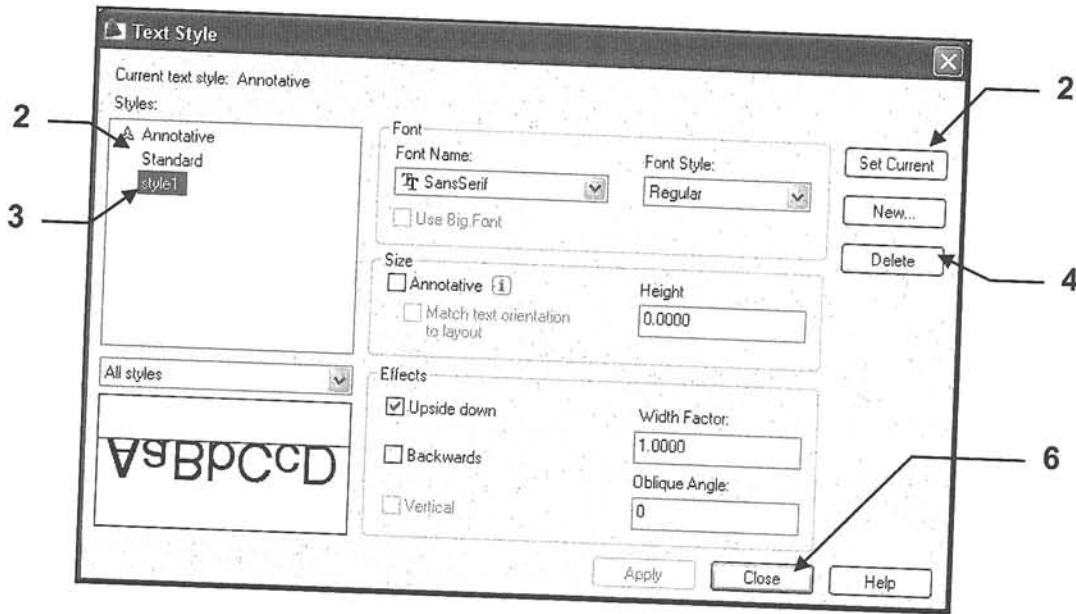

2. First, select a **Text Style** that you do not want to Delete and select **Set Current** button. (You can't Delete a Text Style that is in use.)
3. Select the **Text Style** that you want to Delete.
4. Select the **Delete** button.
5. Warning appears, select **Ok** or **Cancel**
6. Select the **Close** button.



Note: Also refer to page 29-9 for the **PURGE** command. The Purge command will remove any unused text styles, dimension styles, layers and linetypes.

CHANGE EFFECTS OF A TEXT STYLE

1. Select the **TEXT STYLE** command using one of the following:

Ribbon = Annotate tab / Text panel / ↘
or
Keyboard = ST <enter>

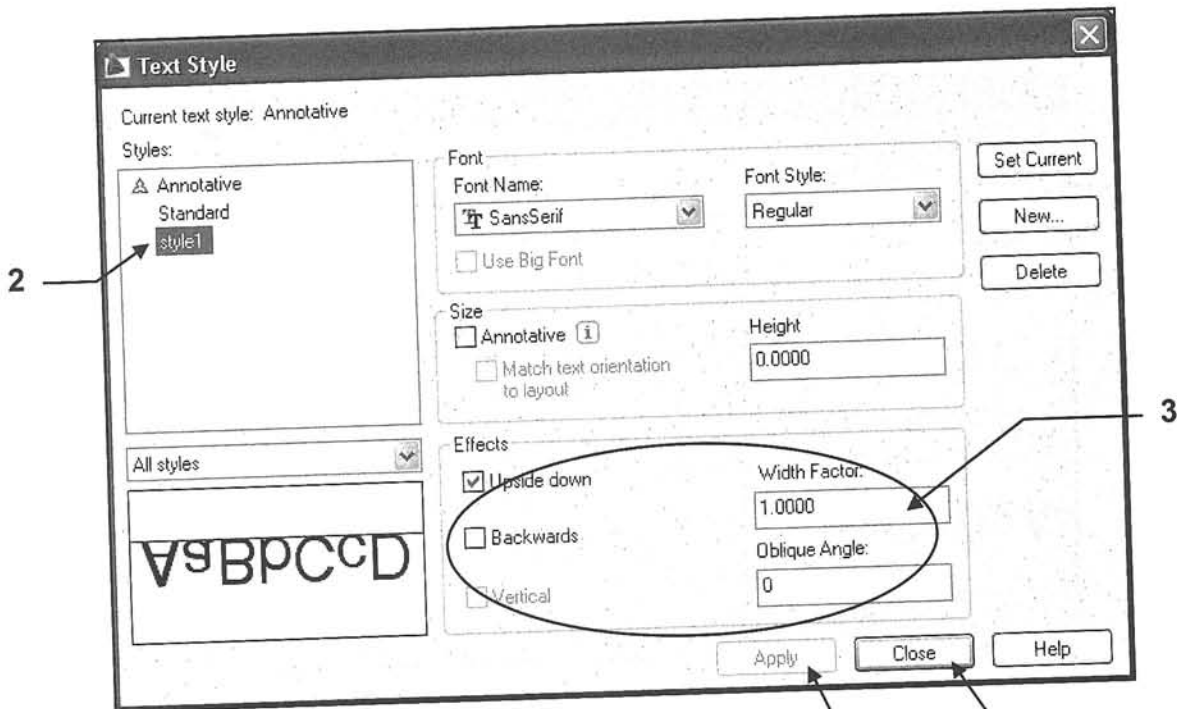
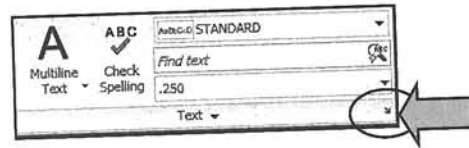

2. Select the **Text Style** you wish to change.

3. Make the changes in the **EFFECTS** boxes.

Note about Vertical:

Only **.shx** fonts can be vertical
Vertical text will not display in the **PREVIEW** box.

4. Select the **Apply** button. (*Apply will stay gray if you did not change a setting.*)
5. Select the **Close** button.

DIVIDE COMMAND

The **DIVIDE** command divides an object mathematically by the **NUMBER** of segments you specify. A **POINT** (object) is placed at each interval on the object.

Note: the object selected is **NOT** broken into segments. The **POINTS** are simply drawn **ON** the object.

EXAMPLE:



This **LINE** has been **DIVIDED** into 4 **EQUAL** lengths.
But remember, the line is not broken into segments.
The **Points** are simply drawn **ON** the object.

1. First open the Point Style box and select the **POINT STYLE** to be placed on the object.

Ribbon = Home tab / Utilities Panel ▼ / Point Style
or
Keyboard = ddptype <enter>

Select either of these **ONLY** when
you want to make the points
disappear yet still be there.

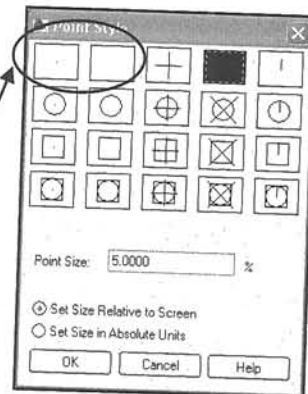

(Refer to page 5-7 if you need a refresher on Points)

2. Next select the **DIVIDE** command using one of the following:

Ribbon = Home tab / Draw panel ▼ / 
or
Keyboard = DIV <enter>

3. Select Object to divide: **select the object to divide**
4. Enter the number of segments or [Block]: **type the number of segments <enter>**

MEASURE COMMAND

The **MEASURE** command is very similar to the **DIVIDE** command because point objects are drawn at intervals on an object. However, the **MEASURE** command allows you to specify the **LENGTH** of the segments rather than the number of segments.

Note: the object selected is **NOT** broken into segments. The **POINTS** are simply drawn **ON** the object.

EXAMPLE:

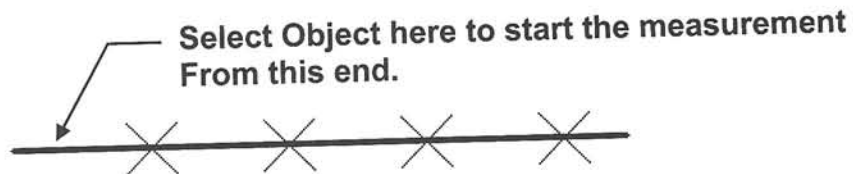

The **MEASURE**ment was started at the left endpoint, and ended just short of the right end of the line. The remainder is less than the measurement length specified. You designate which end you want the measurement to start by selecting the end when prompted to select the object.

1. First open the Point Style box and select the **POINT STYLE** to be placed on the object.

Ribbon = Home tab / Utilities Panel ▼ / Point Style
or
Keyboard = ddptype <enter>

(Refer to page 5-7 if you need a refresher on Points)

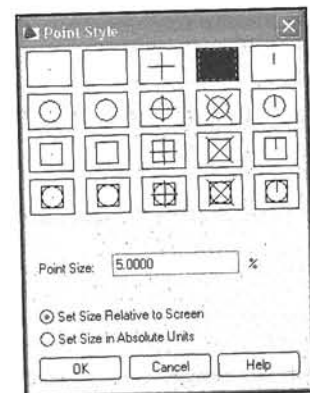

2. Next select the **MEASURE** command using one of the following:

Ribbon = Home tab / Draw panel ▼ / 
or
Keyboard = ME <enter>

3. Select Object to MEASURE: **select the object to MEASURE**
(Note: this selection point is also where the MEASUREment will start.)
4. Specify length of segment or [Block]: **type the length of one segment <enter>**

EXERCISE 25A

INSTRUCTIONS:

1. Start a **New** file using **Border A-2013.dwt**
2. Create the 3 Text Styles shown below and on the next page.
(Style1, Style2 and Style3)
Select all of the options shown.
3. **Save** the drawing as: **EX25A**

STYLE1

Note: Style2 and Style3 on the next page.

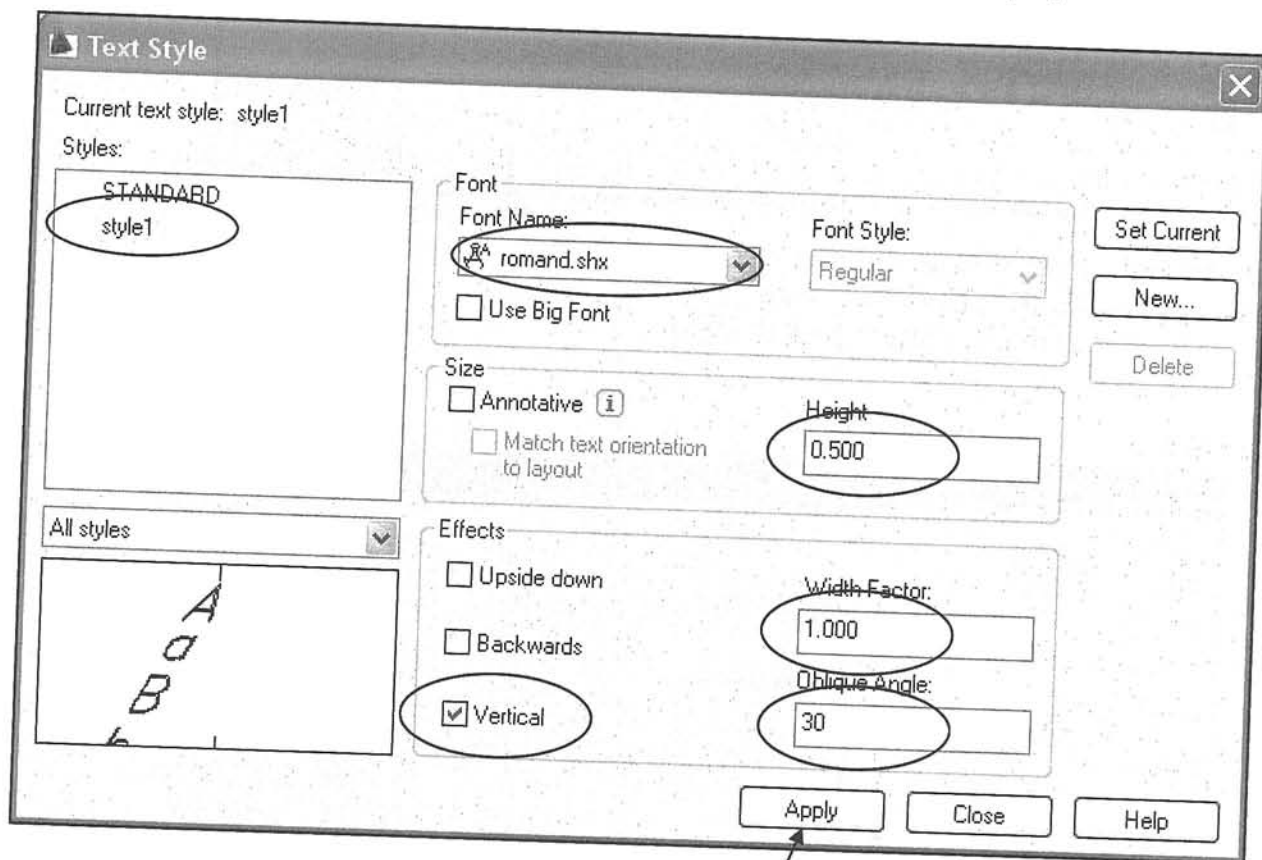

After selecting all the Text features shown above select "Apply", then the "New" button again to start the next Style

EXERCISE 25A....continued

STYLE2

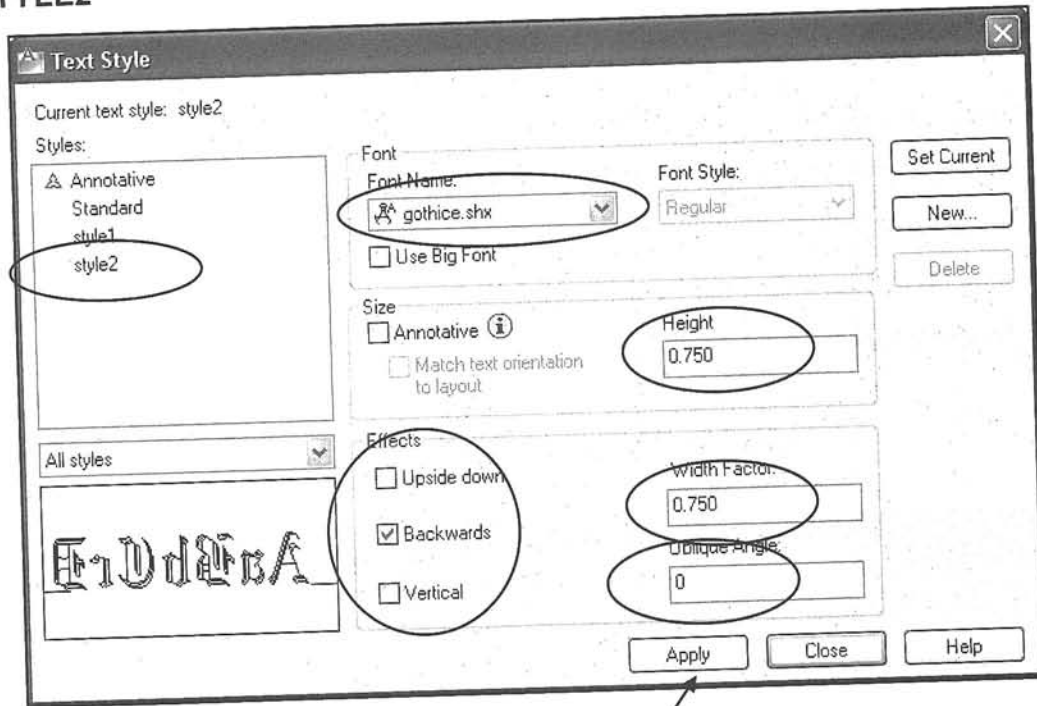

After selecting all the Text features shown above select "Apply", then the "New" button again to start the next Style

STYLE 3

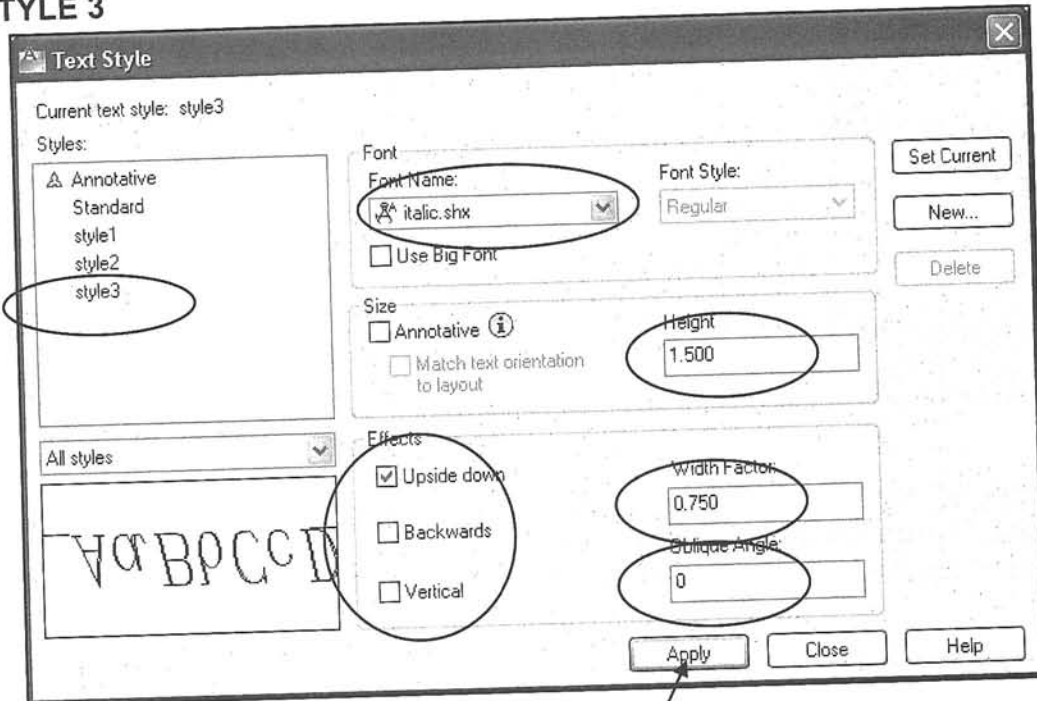

Select Apply button and Close button

EXERCISE 25B

INSTRUCTIONS:

1. Open **EX25A** (If not already open)
2. Before entering text, move the Origin to the lower left corner as shown.
3. Draw the 3 Text Styles using "Single Line Text".

Remember to select the text style before selecting the Single Line text command.

4. Place the start point exactly as shown. (enter coordinates)
5. Use layer Text.
6. Edit the Title and Ex-XX by double clicking on the text. Do not erase and replace.
7. Save as **EX25B**
8. Plot using Page Setup **Class Model A**

Note: Text will not appear backwards until you press enter.

Start Point 5.20,5.90

Start Point 2.60,5.50

Start Point .90. 2.17

Note: Text will not appear upside down until you press enter.

Move Origin here before entering text.

Your Name Here

Using the new Text styles

Ex-25B

EXERCISE 25C

INSTRUCTIONS:

1. Open **EX25B** (if not already open)
2. Change the Text to Text Style "Standard".
 - a. Select all text
 - b. Quick Properties will appear
 - c. Change Text "varies" to "Standard"
3. Edit the Title and Ex-XX by double clicking on the text.
4. Save as **EX25C**
5. Plot using Page Setup **Class Model A**

STYLE1 ^{STYLE2}

STYLE3

Your Name Here

Changing the Text styles

Ex-25C

EXERCISE 25D

INSTRUCTIONS:

1. Open **EX25C** (If not already open)
2. Delete Text Styles 1, 2 and 3 as follows:

- a. Select **TEXT STYLE** box.
- b. Select the "Standard" text style.
- c. Select **Set Current** button. (This makes Standard the current text style)

AutoCAD will not allow you to delete an active or current text style. That is why you must make the "Standard" text style current before you may delete a text style.

- d. Select the style you want to **delete**.
- e. Click on the **DELETE** button.

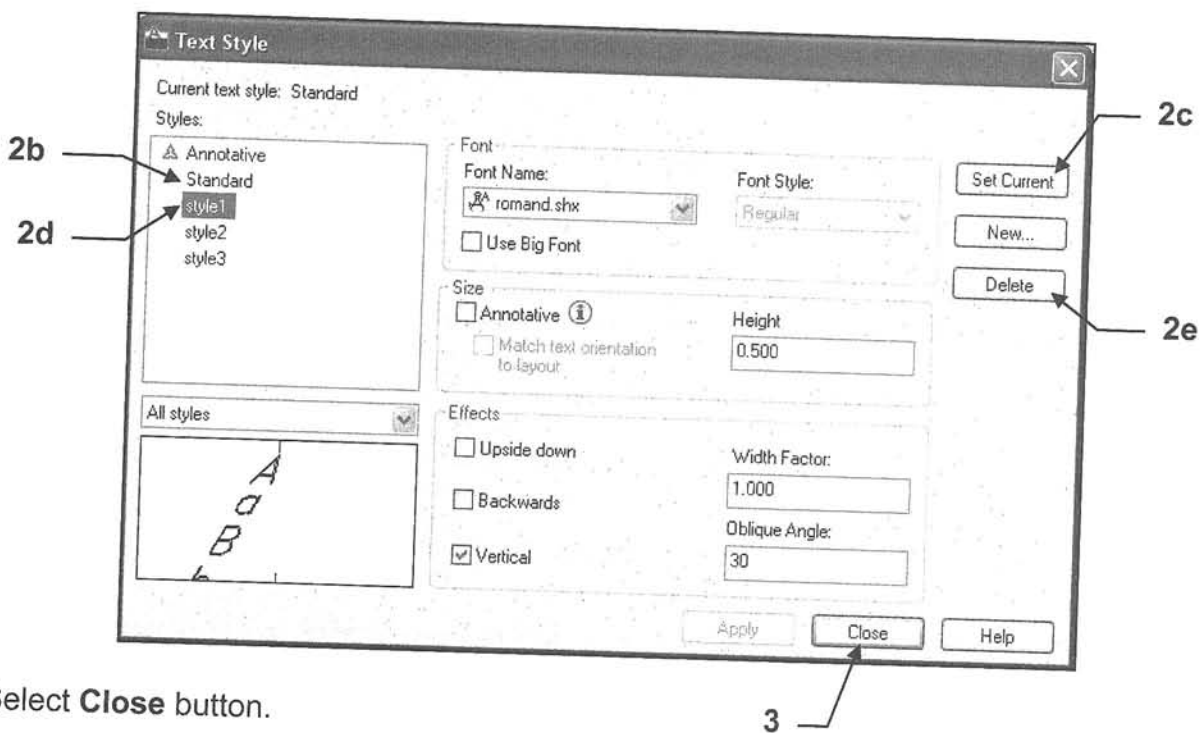

3. Select **Close** button.
4. **Save as: EX25D**

EXERCISE 25E

INSTRUCTIONS:

1. Start a **New** file using **Border A-2013.dwt**
2. Draw the (2) 8" long lines shown below on layer Object line.
3. **Divide** the upper line into 10 equal segments.
4. Using **Measure** create (5) 1.50 long segments on the lower line as shown.
5. Edit the Title and Ex-XX by double clicking on the text. Do not erase and replace.
6. Dimension as shown. (Remember "Node" is the object snap to use for Points)
7. Save as **EX25E**
8. Plot using Page Setup **Class Model A**

The diagram illustrates the setup for Exercise 25E. It consists of two horizontal lines, one above the other, both enclosed in a rectangular frame. The top line is dimensioned as 8.000 units long. Below it, there are 9 'X' marks representing division points, with the text "10 spaces equally spaced" centered between the line and the marks. The bottom line is also dimensioned as 8.000 units long. Below it, there are 4 'X' marks representing division points. Above the bottom line, there are five dimension lines, each labeled "1.500", indicating that the line is divided into five equal segments of 1.500 units each.

Your Name Here	Divide and Measure	Ex-25E
----------------	--------------------	--------

EXERCISE 25F

INSTRUCTIONS:

1. Start a **New** file using **Border A.dwt**
2. Draw the "pretend" house roof plan with fence line shown below.
3. Refer to the next page for instructions and helpful hints.
4. Dimension using Dimension Style "Class Style" and Layer Dimension
5. Edit the Title and Ex-XX by double clicking on the text. Do not erase and replace.
6. Save as **EX25** and Plot using Page Setup **Class Model A**

(Note: You will learn to actually draw a full size house in Lesson 27.)

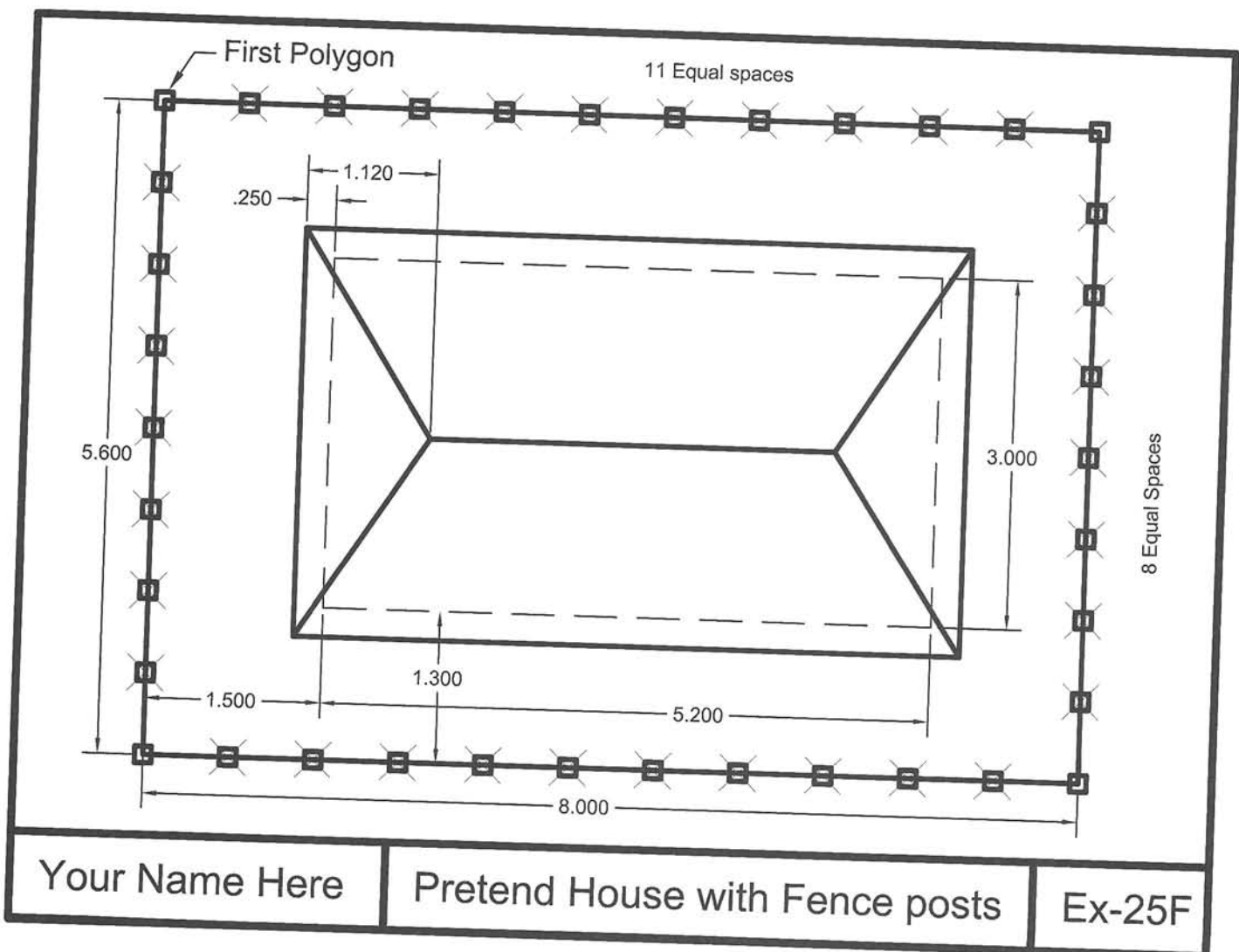

25F Helpful Hints

Step 1.

Draw the "pretend" house roof plan with fence line.
Use Layers Roof, Walls and Hidden Lines.

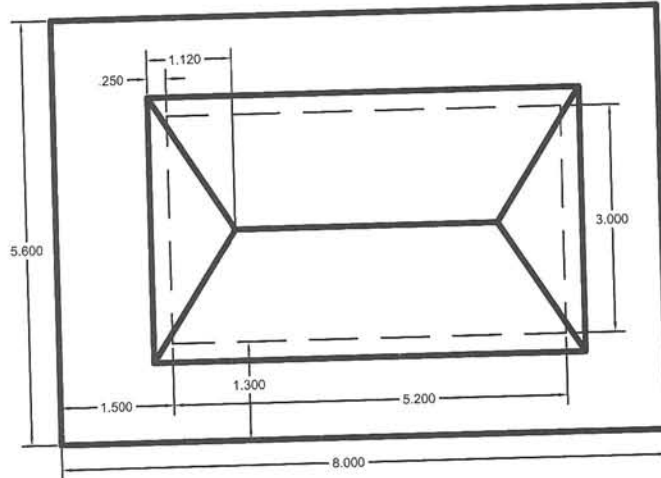

Step 2.

Divide the Fence lines.
11 equal spaces Horizontally
8 equal spaces Vertically

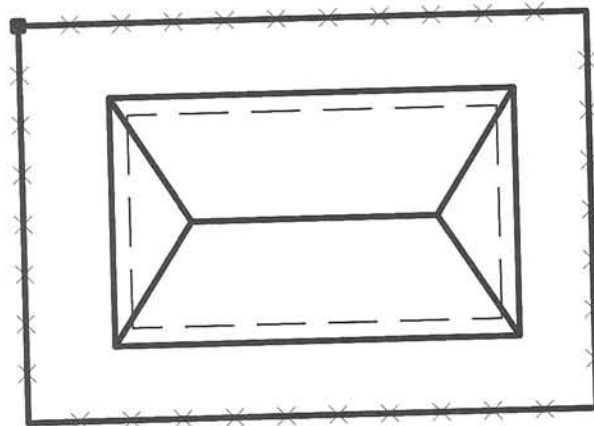

Step 3.

Draw 1 Fence Post at upper left corner using inscribed, 4 sided, .10 radius.

Step 4

Copy Fence Post to the "Points" and Corner. Use object snaps "Node" to snap to the "Points".

Step 5.

Change the Point Style so the Points will not be displayed.

