

LEARNING OBJECTIVES

After completing this lesson, you will be able to:

1. Match an objects properties with another object
2. Create a Revision Cloud
3. Select a Revision Cloud Style
4. "Wipe Out" an area of an object

LESSON 21

MATCH PROPERTIES

Match Properties is used to “paint” the properties of one object to another. This is a simple and useful command. You first select the object that has the desired properties (the source object) and then select the object you want to “paint” the properties to (destination object).

Only one “source object” can be selected but its properties can be painted to any number of “destination objects”.

1. Select the Match Properties command using one of the following:

Ribbon = Home tab / Clipboard panel / 
or
Keyboard = MA <enter>

2. Select source object: ***select the object with the desired properties to match***
3. Select destination object(s) or [Settings]: ***select the object(s) you want to receive the matching properties.***
4. Select destination object(s) or [Settings]: ***select more objects or <enter> to stop.***

Note: If you do not want to match all of the properties, after you have selected the source object, right click and select “Settings” from the short cut menu, before selecting the destination object. Uncheck all the properties you do not want to match and select the OK button. Then select the destination object(s).

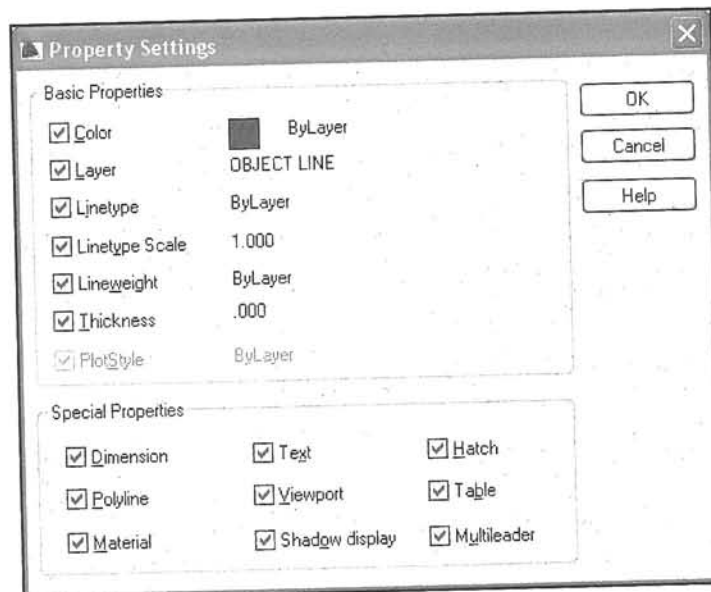

LAYER MATCH

If you draw an object on the wrong layer you can easily change it to the desired layer using Layer Match command. You first select the object that needs to be changed and then select an object that is on the correct layer (object on destination layer).

1. Select the Layer Match command using one of the following:

Ribbon = Home tab / Layers panel / 

or

Keyboard = Laymch <enter>

Command: `_laymch`

2. Select objects to be changed: ***select the objects that need to be changed***
3. Select objects: ***select more objects or <enter> to stop selecting***
4. Select object on destination layer or [Name]: ***select the object that is on the layer that you want to change to***

Note:

You may also easily change the layer of an object to another layer as follows:

1. Select the object that you wish to change.
2. Select the Layer drop down menu and select the layer that you wish the object to be placed on.

For example:

If you had a dimension on the object line layer by mistake.

1. Select the dimension that is mistakenly on the object line layer.

2. Select layer dimension from the drop down menu.

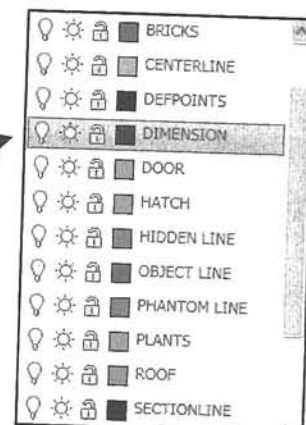

CREATING A REVISION CLOUD

When you make a revision to a drawing it is sometimes helpful to highlight the revision for someone viewing the drawing. A common method to highlight the area is to draw a "Revision Cloud" around the revised area. This can be accomplished easily with the "Revision Cloud" command.

The Revision Cloud command creates a series of sequential arcs to form a cloud shaped object. You set the minimum and maximum arc lengths. (Maximum arc length cannot exceed three times the minimum arc length. Example: Min = 1, Max can be 3 or less) If you set the minimum and maximum different lengths the arcs will vary in size and will display an irregular appearance.

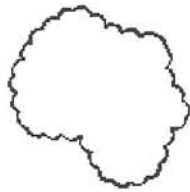

Min & Max same length



Min & Max different length

To draw a Revision Cloud you specify the start point with a left click then drag the cursor to form the outline. AutoCAD automatically draws the arcs. When the cursor gets very close to the start point, AutoCAD snaps the last arc to the first arc and closes the shape.

1. Select the Revision Cloud command using one of the following:

Ribbon = Home tab / Draw ▼ panel / 
or
Keyboard = Revcloud <enter>

Command: `_revcloud`

Minimum arc length: .50 Maximum arc length: .50 Style: Normal

2. Specify start point or [Arc length/Object/Style] <Object>: **Select "Arc length"**
3. Specify minimum length of arc <.50>: **Specify the minimum arc length**
4. Specify maximum length of arc <.50>: **Specify the maximum arc length**
5. Specify start point or [Arc length/Object/Style] <Object>: **Place cursor at start location & left click.**
6. Guide crosshairs along cloud path...**Move the cursor to create the cloud outline.**
7. Revision cloud finished. **When the cursor approaches the start point, the cloud closes automatically.**

CONVERT A CLOSED OBJECT TO A REVISION CLOUD

You can convert a closed object, such as a circle, ellipse, rectangle or closed polyline to a revision cloud. The original object is deleted when it is converted.

(If you want the original object to remain, in addition to the new rev cloud, set the variable "delobj" to "0". The default setting is "1".)

1. Draw a closed object such as a circle.
2. Select the Revision Cloud command using one of the following:

Ribbon = Home tab / Draw ▼ panel / 

or

Keyboard = Revcloud <enter>

Command: _revcloud

Minimum arc length: .50 Maximum arc length: .50 Style: Normal

3. Specify start point or [Arc length/Object/Style] <Object>: **Select "Arc length"**
4. Specify minimum length of arc <.50>: **Specify the minimum arc length**
5. Specify maximum length of arc <.50>: **Specify the maximum arc length**
6. Specify start point or [Arc length/Object/Style] <Object>: **Select "Object"**.
7. Select object: **Select the object to convert**
8. Select object: Reverse direction [Yes/No] <No>: **Select Yes or No**
Revision cloud finished.

Reverse direction?

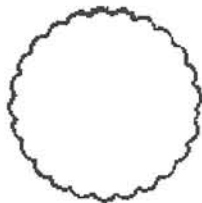

NO

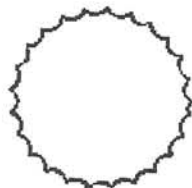

YES

NOTE:

The Match Properties command will not match the arc length from the source cloud to the destination cloud.

REVISION CLOUD STYLE

You may select one of 2 styles for the Revision Cloud; **Normal** or **Calligraphy**.

Normal will draw the cloud with one line width.

Calligraphy will draw the cloud with variable line widths to appear as though you used a chiseled calligraphy pen.

Normal



Calligraphy



1. Select the Revision Cloud command using one of the following:

Ribbon = Home tab / Draw ▼ panel / 

or

Keyboard = Revcloud <enter>

Command: `_revcloud`

Minimum arc length: .50 Maximum arc length: 1.00 Style: Normal

2. Specify start point or [Arc length/Object/Style] <Object>: **Select "Style"<enter>**
3. Select arc style [Normal/Calligraphy] <Calligraphy>: **Select "N or C"<enter>**
4. Specify start point or [Arc length/Object/Style] <Object>: **Select "Arc length"**
5. Specify minimum length of arc <.50>: **Specify the minimum arc length**
6. Specify maximum length of arc <1.00>: **Specify the maximum arc length**
7. Specify start point or [Object] <Object>: **Place cursor at start location & left click.**
8. Guide crosshairs along cloud path...**Move the cursor to create the cloud outline.**
9. Revision cloud finished. **When the cursor approaches the start point, the cloud closes automatically.**

WIPEOUT

The Wipeout command creates a blank area that covers existing objects. The area has a background that matches the background of the drawing area. This area is bounded by the wipeout frame, which you can turn on or off.

1. Select the Wipeout command using one of the following:

Ribbon = Home tab / Draw ▾ panel / 
or
Keyboard = Wipeout <enter>

2. Command: `_wipeout` Specify first point or [Frames/Polyline] <Polyline>: **specify the first point of the shape (P1)**
3. Specify next point: **specify the next point (P2)**
4. Specify next point or [Undo]: **specify the next point (P3)**
5. Specify next point or [Undo]: **specify the next point or <enter> to stop**

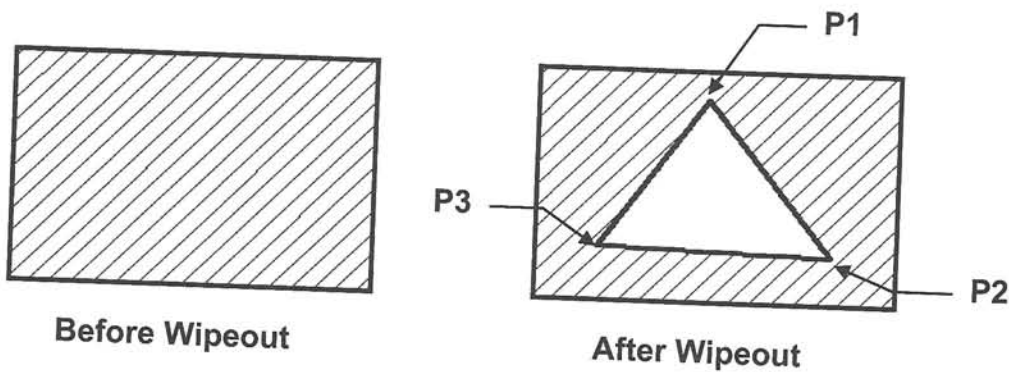

TURNING FRAMES ON OR OFF

1. Select the Wipeout command.
2. Select the "Frames" option.
3. Enter ON or OFF.

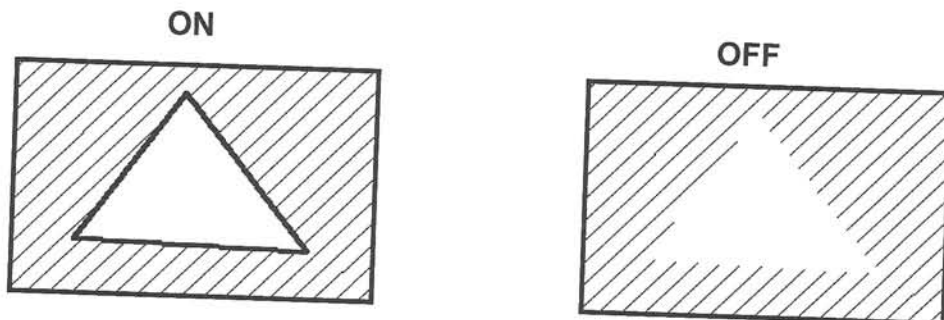

Note: If you want to move the objects and the wipeout area, you must select both and move them at the same time. Do not move them separately.

EXERCISE 21A

INSTRUCTIONS:

1. Open **EX5F.dwg**
2. Using **Match Properties**, change the properties of the Polygon to the same properties as the Donut.
3. Using **Wipeout**, block out the bottom donut approximately as shown.
4. Edit the Title and Ex-XX by double clicking on the text. Do not erase and replace.
5. Save as **EX21A**
6. Plot using Page Setup **Class Model A**

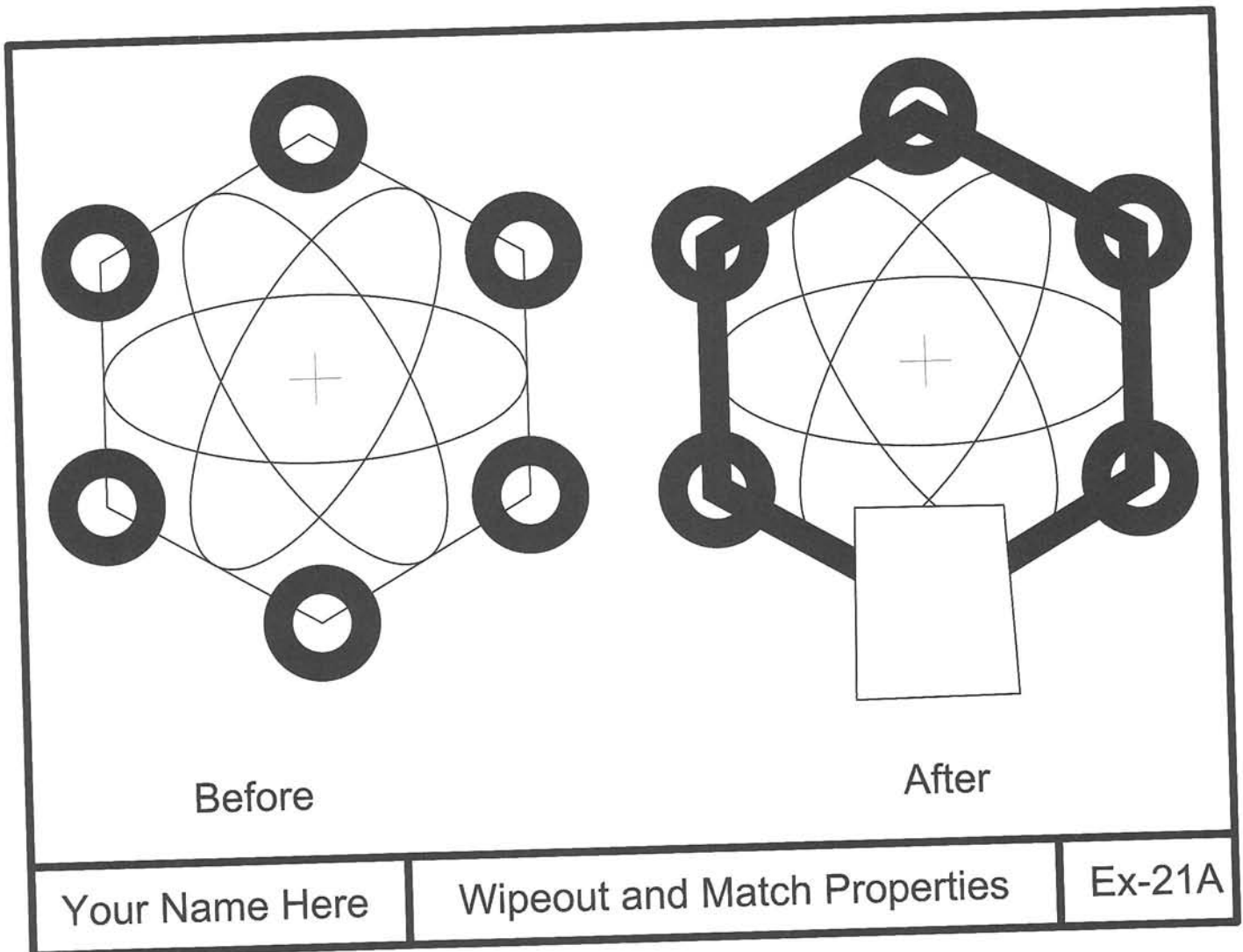

EXERCISE 21B

INSTRUCTIONS:

1. Start a **New** file using **Border A-2013.dwt**
2. Draw the Revision clouds below:
 - #1: Set Min. and Max. Arc Length to .500
 - #2: Set Min. Arc Length to .500 and Max. Arc Length to 1.00
 - #3: Same as #2 but change Style to Calligraphy.
3. Draw (2) 2.50 Diameter Circles and Convert to Revision clouds.
Set Min and Max Arc Length to .50 Set Style to Normal
#4 Reverse = No #5 Reverse = Yes
4. Use Layer Object line.
5. Edit the Title and Ex-XX by double clicking on the text. Do not erase and replace.
6. Save as **EX21B**
7. Plot using Page Setup **Class Model A**

#1	#3	
#2	#4	#5
Your Name Here	Revision Cloud	Ex-21B

EXERCISE 21C

INSTRUCTIONS:

1. Start a **New** file using **Border A-2013.dwt**
2. The drawing below is designed to give you more practice drawing objects and dimensioning. Use any method that you have learned in the previous lessons.
3. Edit the Title and Ex-XX by double clicking on the text. Do not erase and replace.
4. Save as **EX21C**
5. Plot using Page Setup **Class Model A**

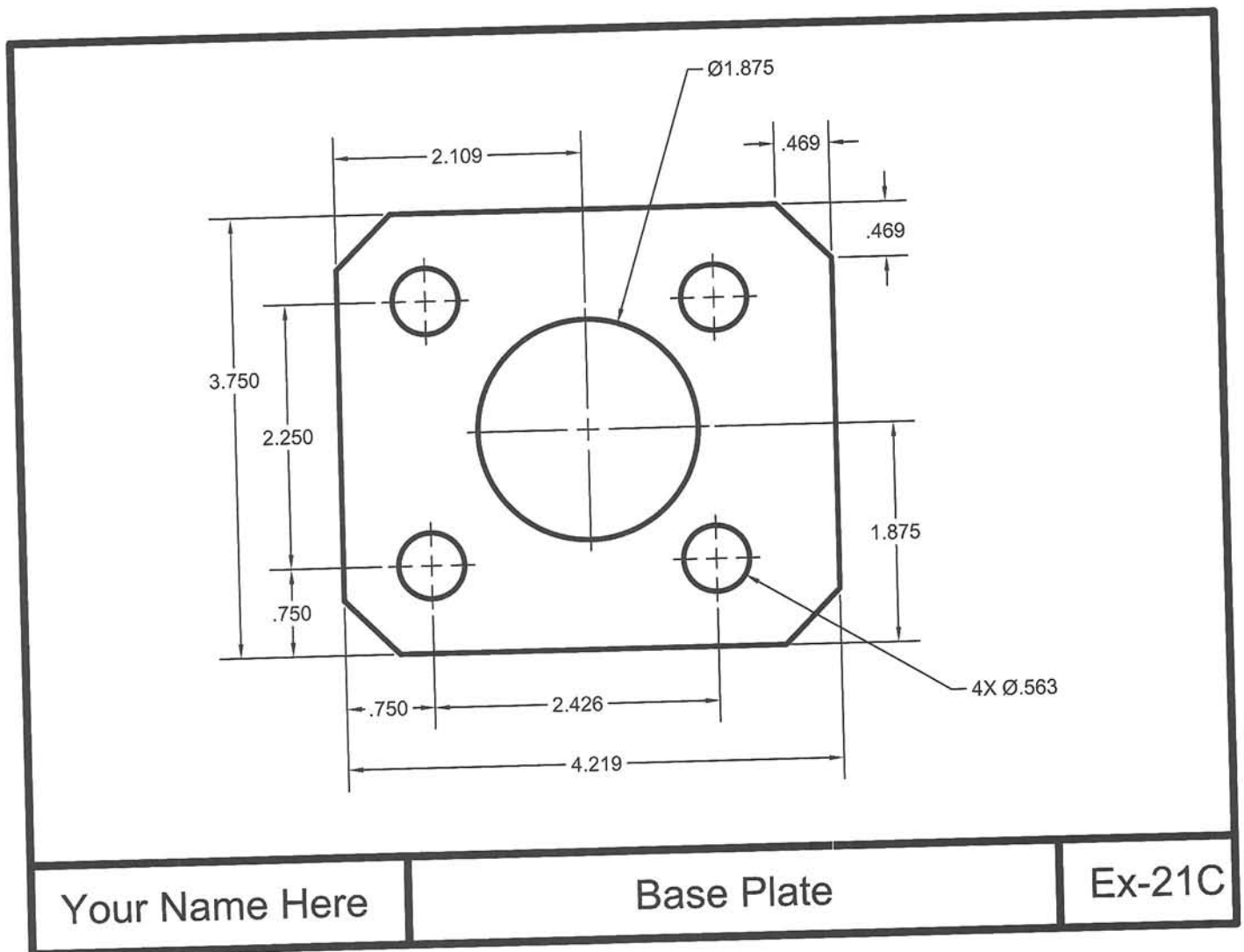

Your Name Here

Base Plate

Ex-21C

EXERCISE 21D

INSTRUCTIONS:

1. Start a **New** file using **Border A-2013.dwt**
2. The drawing below is designed to give you more practice drawing objects and dimensioning. Use any method that you have learned in the previous lessons.
3. Edit the Title and Ex-XX by double clicking on the text. Do not erase and replace.
4. Save as **EX21D**
5. Plot using Page Setup **Class Model A**

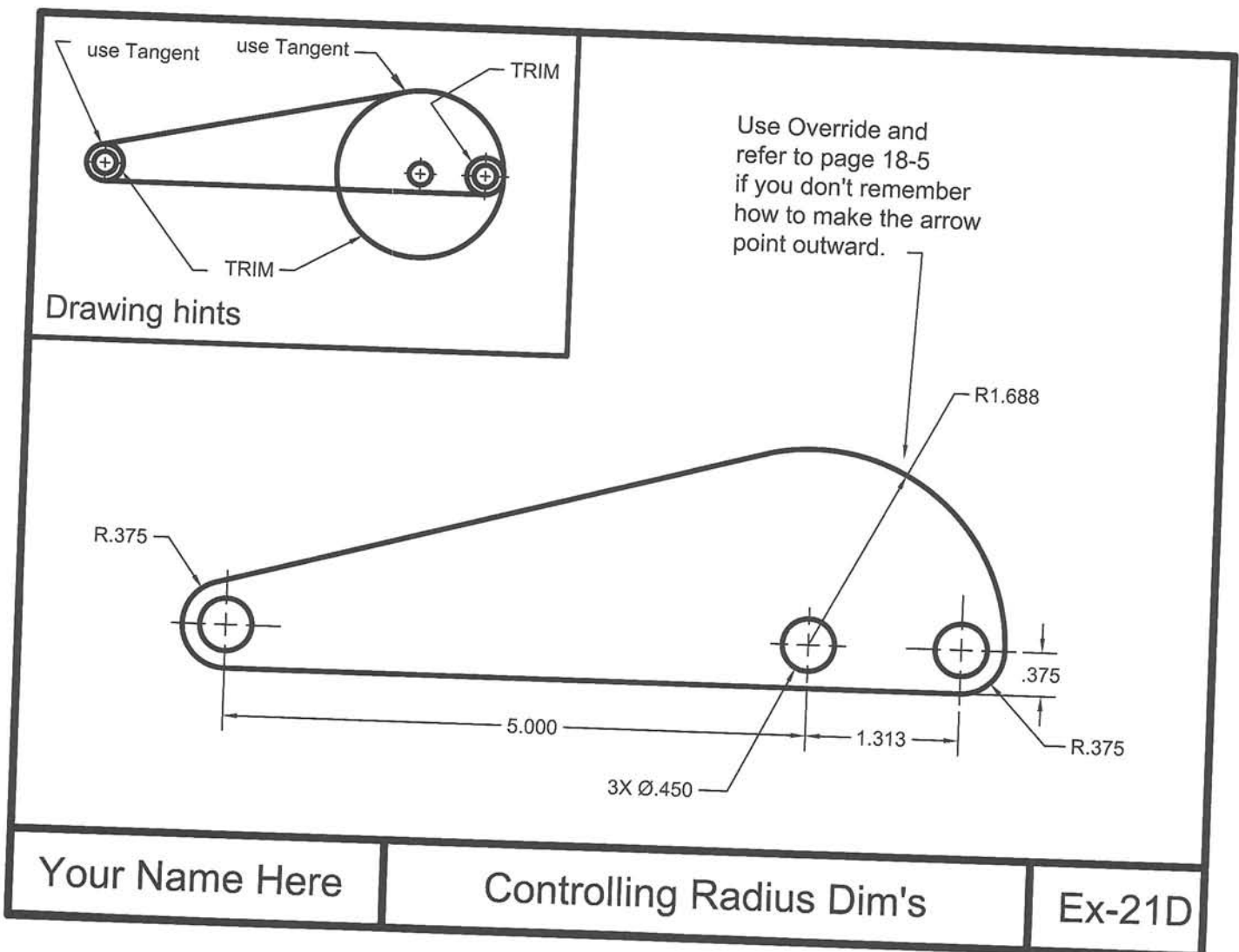

EXERCISE 21E

INSTRUCTIONS:

1. Start a **New** file using **Border A-2013.dwt**
2. The drawing below is designed to give you more practice drawing objects and dimensioning. Use any method that you have learned in the previous lessons.
3. Edit the Title and Ex-XX by double clicking on the text. Do not erase and replace.
4. Save as **EX21E**
5. Plot using Page Setup **Class Model A**

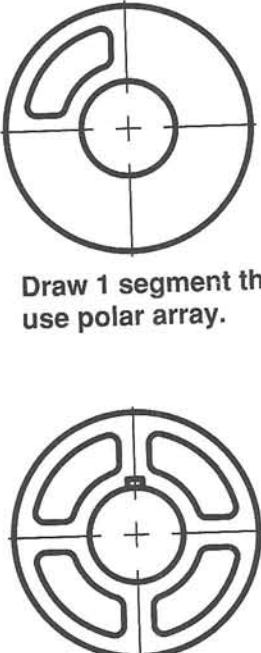
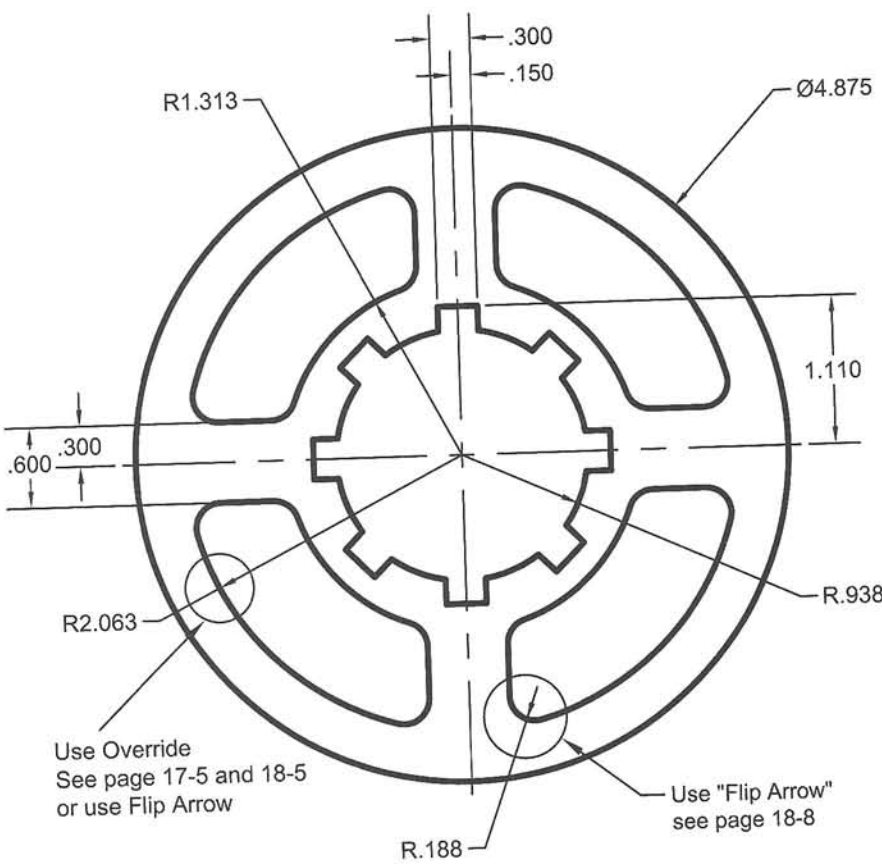
 <p>Draw 1 segment then use polar array.</p> <p>Draw 1 slot then use polar array then trim.</p> <p>Construction Hints</p>	 <p>R1.313</p> <p>Ø4.875</p> <p>.300</p> <p>.150</p> <p>1.110</p> <p>.600</p> <p>.300</p> <p>R2.063</p> <p>R.938</p> <p>R.188</p> <p>Use Override See page 17-5 and 18-5 or use Flip Arrow</p> <p>Use "Flip Arrow" see page 18-8</p>	
Your Name Here	Circular Pattern	Ex-21E