

LEARNING OBJECTIVES

After completing this lesson, you will be able to:

1. Add Diameter, Radius and Angular dimensions to a drawing
2. Draw and control Center Marks
3. Flip the direction of an arrowhead
4. Understand the need for Sub-styles
5. Create a sub-style

LESSON 18

DIMENSIONING DIAMETERS

The **DIAMETER** dimensioning command should be used when dimensioning circles and arcs of more than 180 degrees. AutoCAD measures the selected circle or arc and displays the dimension text with the diameter symbol (\emptyset) in front of it.

1. Select the Diameter command using one of the following:

Ribbon = Annotate tab / Dimension panel /  **Select** ▼
or
Keyboard = Dimdiameter <enter>

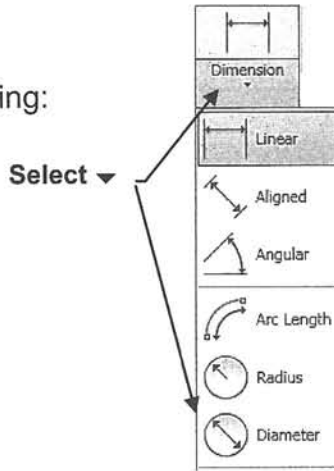

2. Select arc or circle: ***select the arc or circle (P1) do not use object snap.***
Dimension text = ***the diameter will be displayed here.***
3. Specify dimension line location or [Mtext/Text/Angle]: ***place dimension text location (P2)***

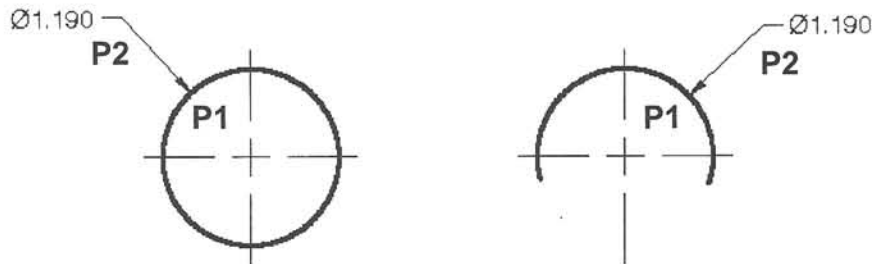

Center marks are automatically drawn as you use the diameter dimensioning command. If the circle already has a center mark or you do not want a center mark, set the center mark setting to **NONE** (Dimension Style / Symbols and Arrows tab) before using Diameter dimensioning. (Refer to 18-7)

DIMENSIONING DIAMETERS....continued

Controlling the diameter dimension appearance.

If you would like your Diameter dimensions to appear as shown in the two examples below, you must change some setting in the Dimension Style **Fit tab**.

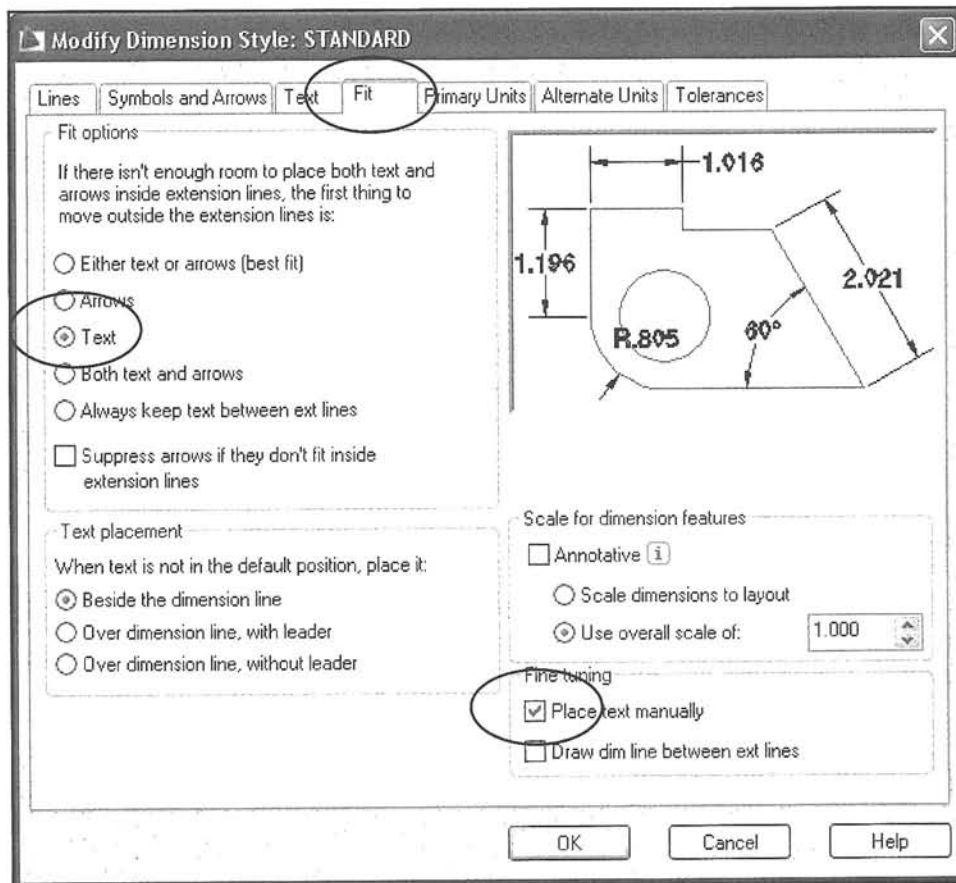
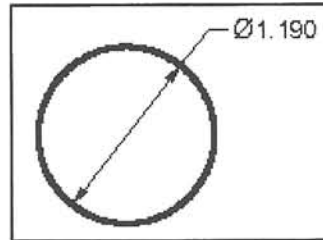
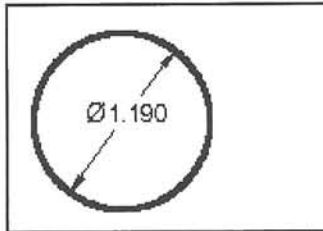

DIMENSIONING RADII

The **Radius** dimensioning command should be used when dimensioning arcs of less than 180 degrees. AutoCAD measures the selected arc and displays the dimension text with the radius symbol (R) in front of it.

1. Select the Radius command using one of the following:

Ribbon = Annotate tab / Dimension panel / 
or
Keyboard = Dimradius <enter>

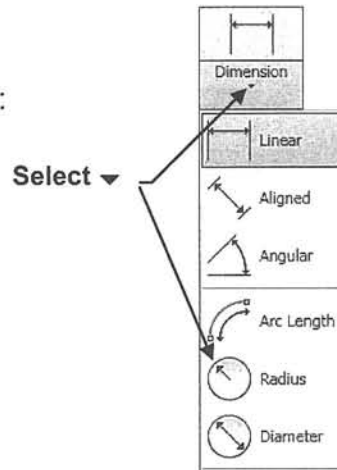

2. Select arc or circle: ***select the arc (P1) do not use object snap.***
Dimension text = ***the radius will be displayed here.***
3. Specify dimension line location or [Mtext/Text/Angle]: ***place dimension text location (P2)***

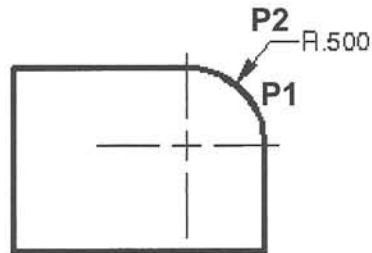

Center marks are automatically drawn as you use the radius dimensioning command. If you do not want a center mark, set the center mark setting to **NONE** (Dimension Style / Symbols and Arrows tab) before using Diameter dimensioning. (Refer to 18-7)

DIMENSIONING RADII

Controlling the radius dimension appearance.

If you would like your Radius dimensions to appear as shown in the example below, you must change the **“Fit Options”** and **“Fine Tuning”** in the **Fit tab** in your Dimension Style.

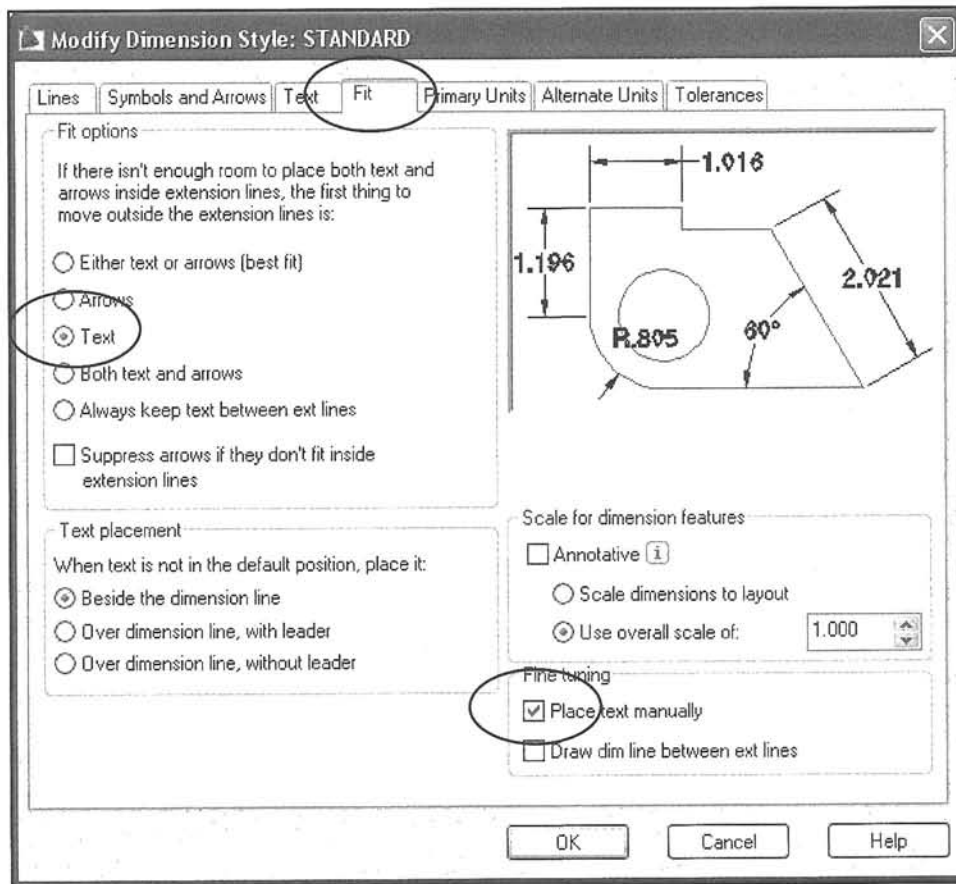
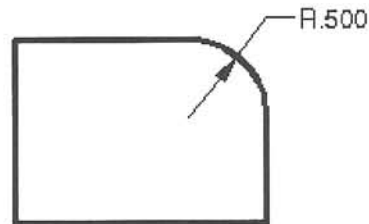

ANGULAR DIMENSIONING

The **ANGULAR** dimension command is used to create an angular dimension between two lines that form an angle. AutoCAD determines the angle between the selected lines and displays the dimension text followed by a degree ($^{\circ}$) symbol.

1. Select the **ANGULAR** command.

Ribbon = Annotate tab / Dimension panel /
or
Keyboard = Dimangular <enter>

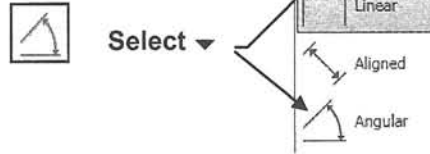

2. Select arc, circle, line, or <specify vertex>: **select the first line that forms the angle (P1) location is not important, do not use object snap.**
3. Select second line: **select the second line that forms the angle (P2)**
4. Specify dimension arc line location or [Mtext/Text/Angle]: **place dimension text location (P3)**

Dimension text = **angle will be displayed here**

Any of the 4 angular dimensions shown below can be displayed by moving the cursor in the direction of the dimension after selecting the 2 lines (P1 and P2) that form the angle.

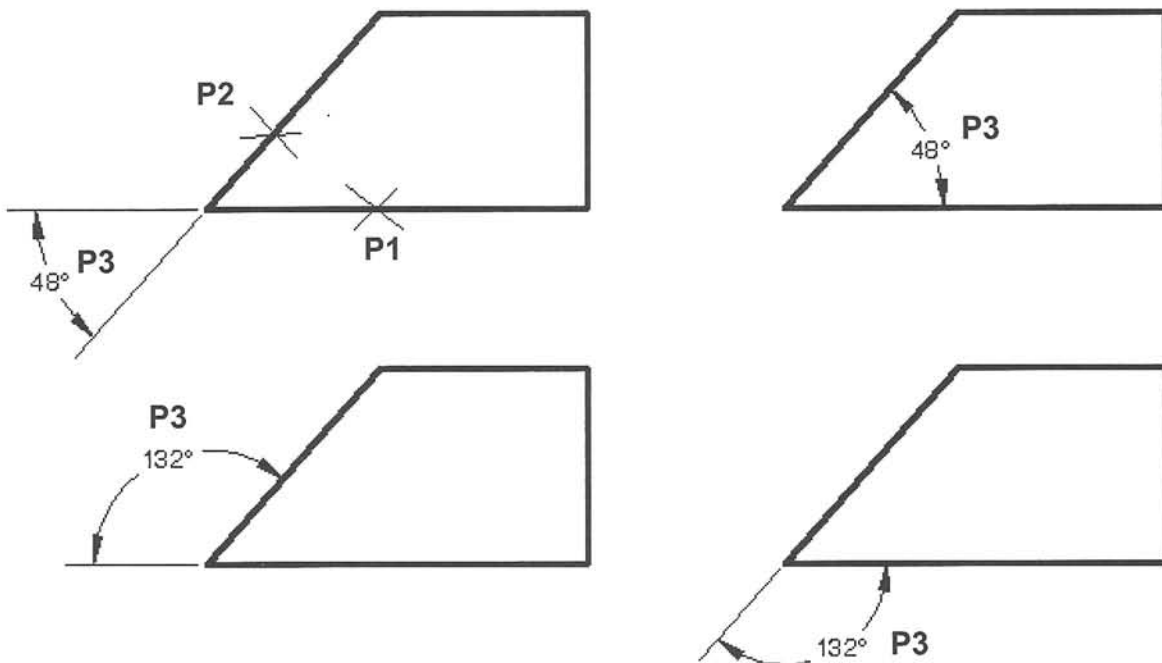

CENTERMARK

CENTERMARKS can ONLY be drawn with circular objects like Circles and Arcs. You set the size and type.

The Center Mark has three types, **None**, **Mark** and **Line** as shown below.

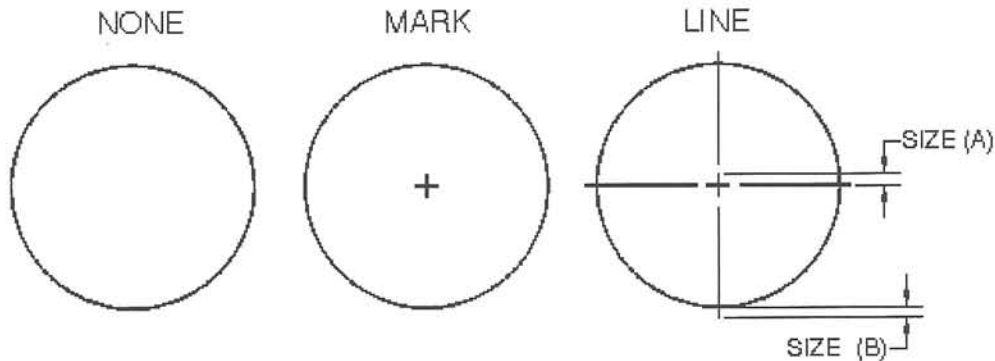

What does “SIZE” mean?

The **size** setting determines both, (A) the length of half of the intersection line and (B) the length extending beyond the circle. (See above right)

Where do you set the CENTERMARK “TYPE” and “SIZE”

1. Select the **Dimension Style** command.
2. Select: **Modify or Override**.
3. Select: **SYMBOLS and ARROWS** tab
4. Select the **Center mark type**
5. Set the **Size**.

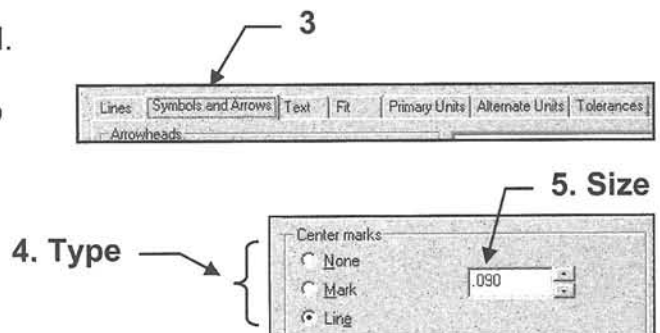

To draw a CENTER MARK

1. Select the **Center mark** command using one of the following:
Ribbon = Annotation tab / Dimension ▼ panel / 
or
Keyboard = DCE <enter>
2. Select arc or circle: **select the arc or circle with the cursor**.

FLIP ARROW

You can easily **flip** the direction of the arrowhead using the **Flip Arrow** option.

How to Flip an arrowhead.

1. Select the dimension that you wish to Flip.

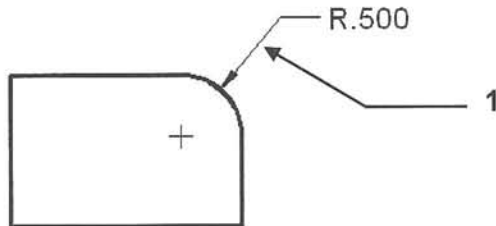

2. Rest your cursor on the arrow grip. (Do not press button, just rest cursor)
3. Select **Flip Arrow** from the short cut menu.

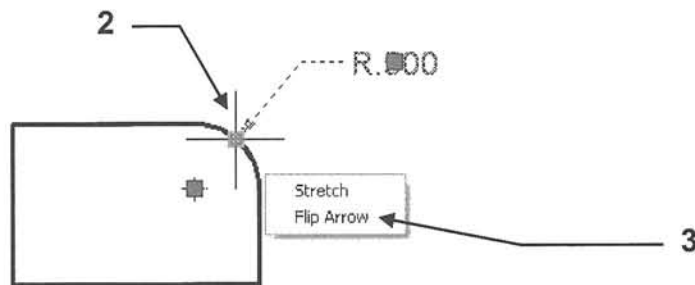

4. The arrowhead Flips.

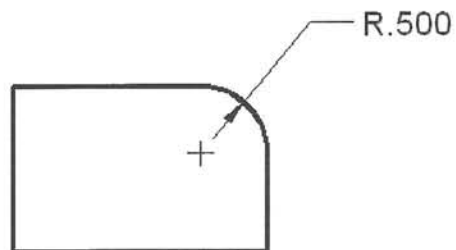

5. Press **Esc** and the grips will disappear. (Do not press <enter>).

CREATING A DIMENSION SUB-STYLE

In Lesson 16 you learned how to create a Dimension Style named Class Style. All of the dimension created with that style appear identical because they have the same settings. Now you are going to learn how to create a “Sub-Style” of the Class Style.

For example:

If you wanted all of the **Diameter** dimensions to have a centerline automatically displayed but you did not want a centerline displayed when using the **Radius** dimension command. To achieve this, you must create a “sub-style” for all **Radius** dimensions.

Sub-styles have also been called “children” of the “Parent” dimension style. As a result, they form a family.

A Sub-style is permanent, unlike the Override command, which is temporary.

Note: This sounds much more complicated than it is. Just follow the steps below. It is very easy.

How to create a sub-style for Radius dimensions.

You will set the center mark to None for the Radius command only. The Diameter command center mark will not change.

1. Start a **New** file using **Border A-2012.dwt** drawing.
2. Select the **DIMENSION / STYLE** command. (Refer to page 16-8)
3. Select “**Class Style**” from the Style List.
4. Select the **NEW** button.

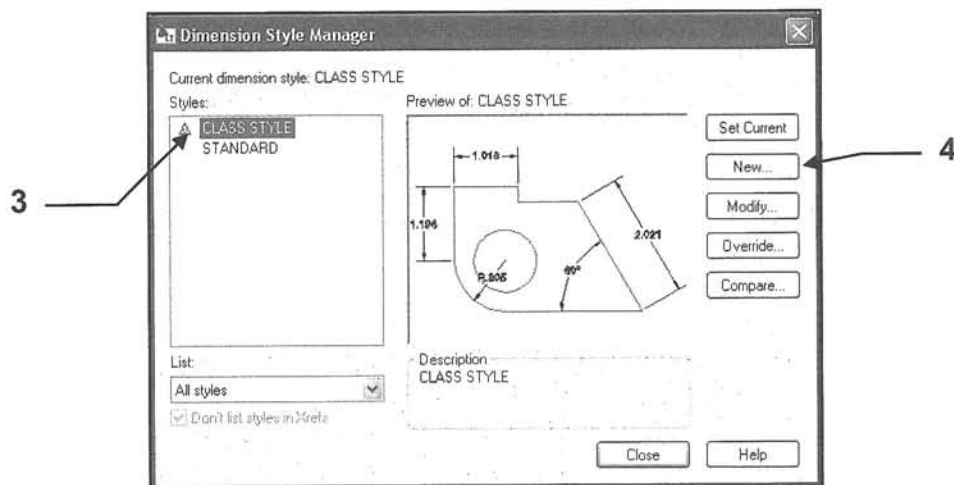

Continued on the next page...

CREATING A DIMENSION SUB-STYLE....continued

5. Change the "Use for" to: **Radius Dimensions**

6. Select **Continue**

This will turn gray. That's OK

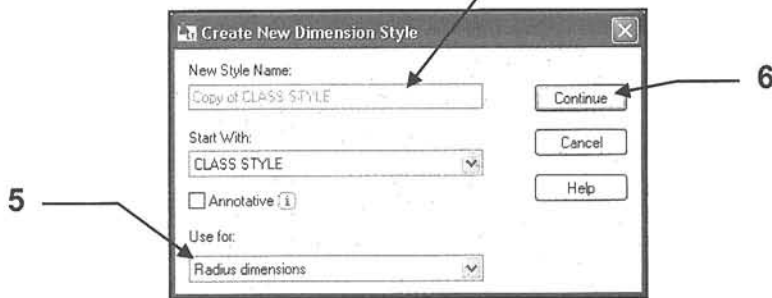

7. Select the **Symbols and Arrows** tab.

8. Change the "Center Marks to **NONE**

9. Select the **OK** button

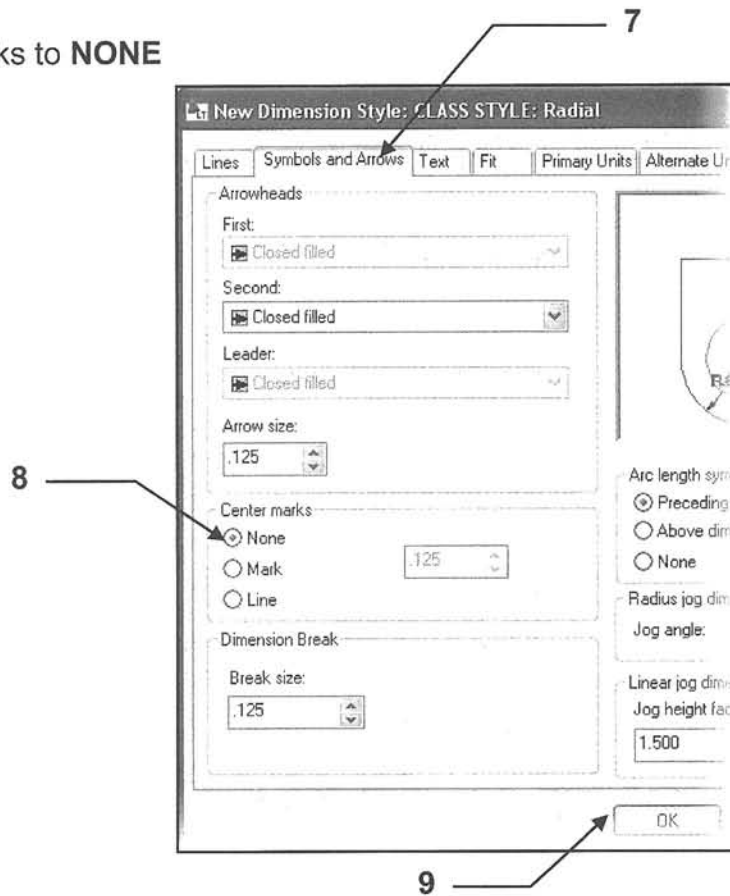

10. You now have a sub-style that will automatically override the basic "Class Style" whenever you use a Radius command. Diameter dimensions will have centermarks and Radius dimensions will not.

If you would like to keep this sub-style re-save the template.

10

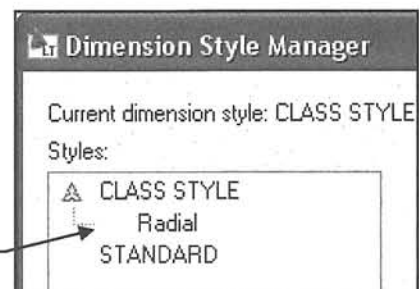

EXERCISE 18A

INSTRUCTIONS:

1. Start a **New** file using **Border A-2013.dwt**
2. Draw the objects below using layer Object line.
3. Dimension as shown using Linear, Diameter and Radius. Use Layer Dimension
4. Edit the Title and Ex-XX by double clicking on the text. Do not erase and replace.
5. Save as **EX18A**
6. Plot using Page Setup **Class Model A**

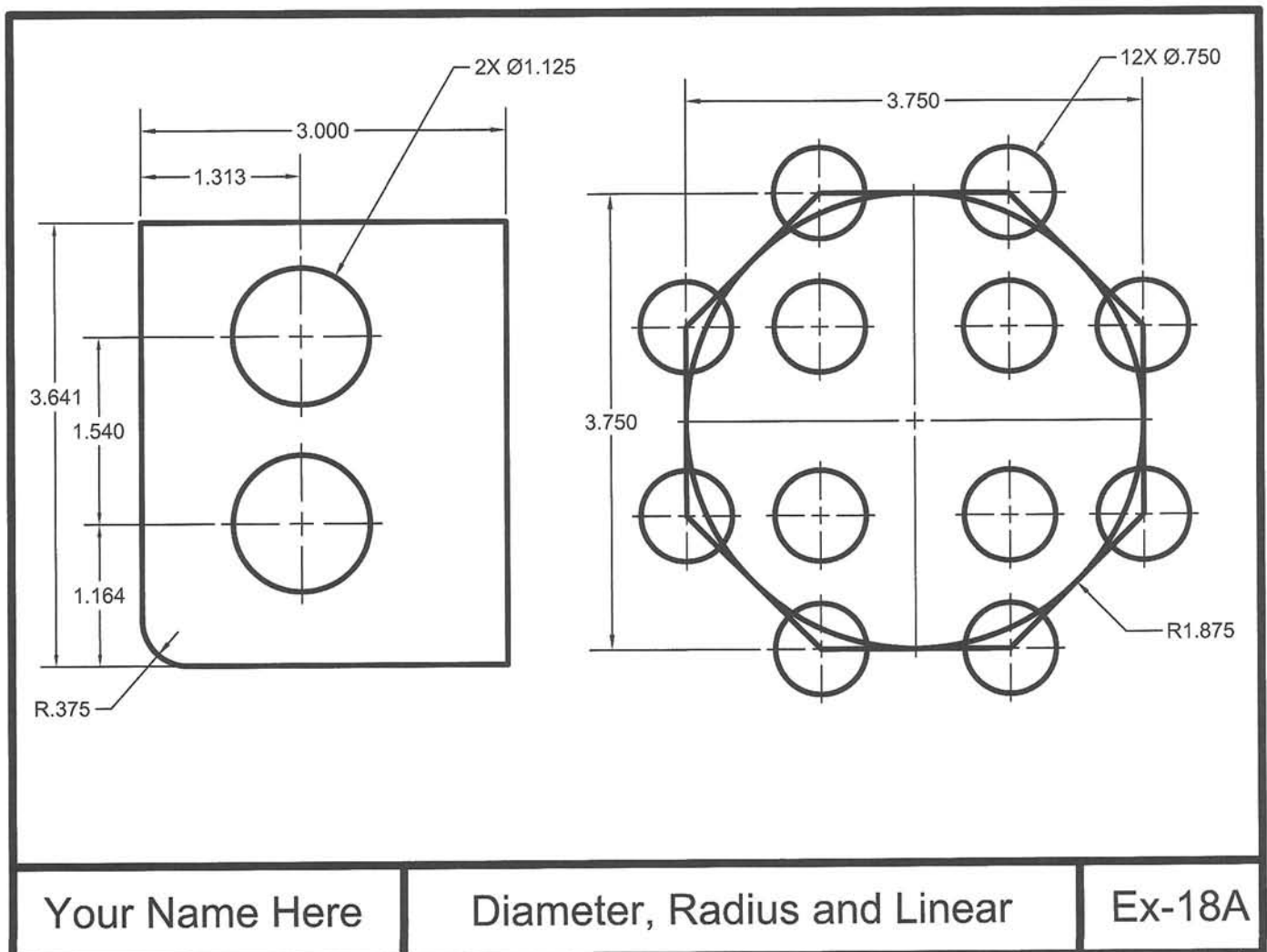

EXERCISE 18B

INSTRUCTIONS:

1. Start a **New** file using **Border A-2013.dwt**
2. Draw the objects below using layer Object line.

Note: Refer to the next page for drawing hints.

3. Dimension as shown using Linear, Diameter and Angular. Use Layer Dimension
4. Edit the Title and Ex-XX by double clicking on the text. Do not erase and replace.
5. Save as **EX18B**
6. Plot using Page Setup **Class Model A**

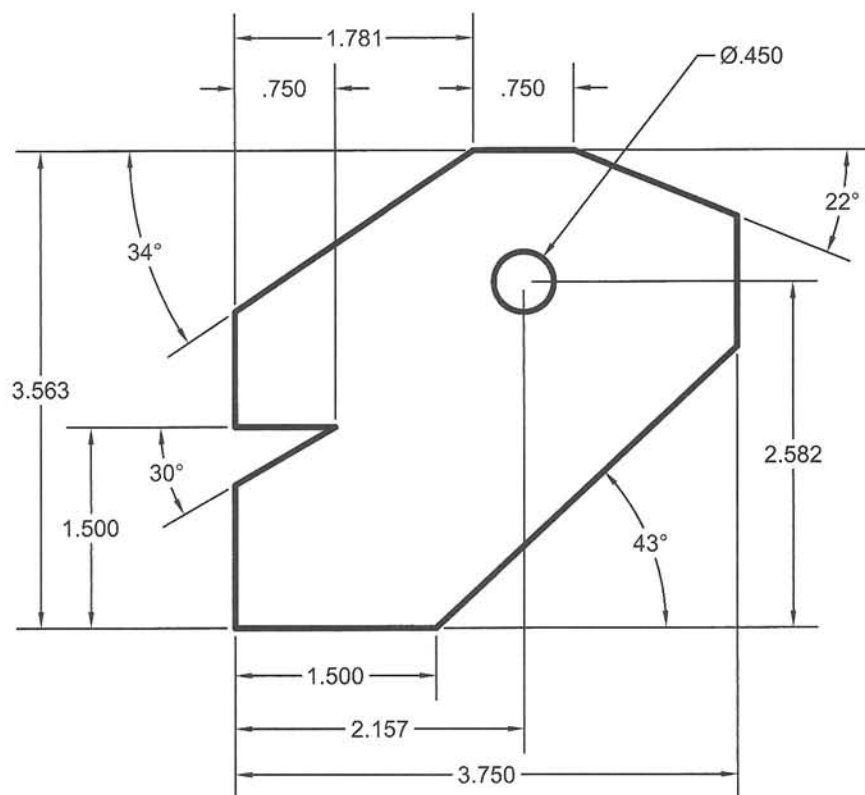

Refer to the next page for drawing hints

Your Name Here

Linear, Diameter and Angular

Ex-18B

EXERCISE 18B-Helper

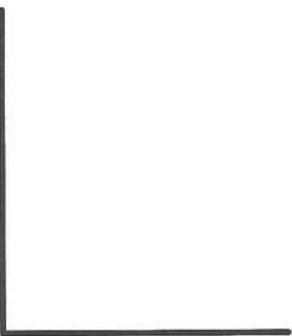
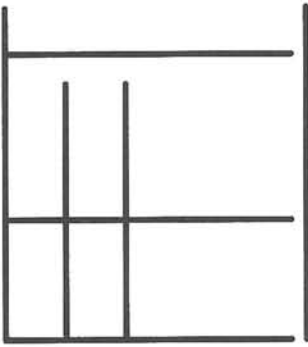
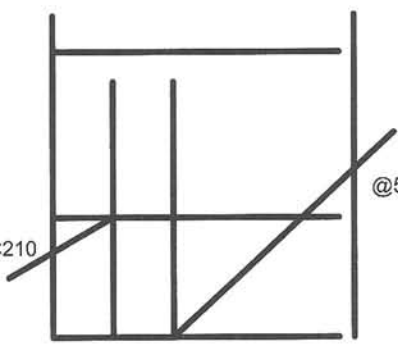
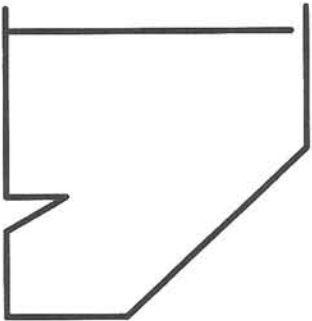
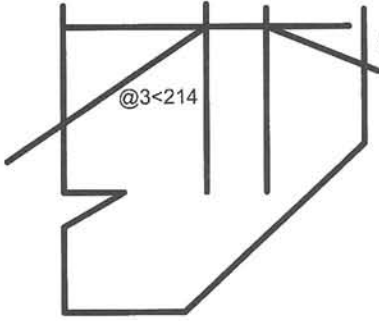
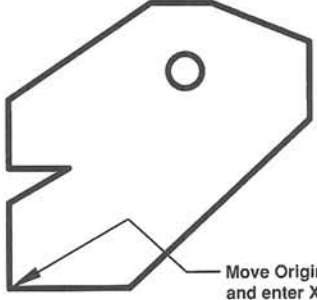
		
<p>Step 1. Draw horizontal and vertical lines</p>	<p>Step 2. Offset some lines.</p>	<p>Step 3. Use "Polar" input to draw the 2 angled lines.</p>
		
<p>Step 4. Trim the lines so it doesn't get confusing.</p>	<p>Step 5. Offset some more lines. Use "Polar" input again.</p>	<p>Step 6. Trim.</p>
<p>Your Name Here</p>	<p>Drawing hints for Ex-18C</p>	<p>Ex-18B</p>

EXERCISE 18C

INSTRUCTIONS:

1. Start a **New** file using **Border A-2013.dwt**
2. Draw the objects below using layer **Object** line.
3. Dimension as shown using Linear, Diameter and Radius. Use Layer **Dimension**
4. Edit the Title and Ex-XX by double clicking on the text. Do not erase and replace.
5. Save as **EX18C**
6. Plot using Page Setup **Class Model A**

