

## CHAPTER 6 AUXILIARY DRAWINGS

A normal surface on an object will always be parallel to the planes of projection and the normal surface will appear true size. An inclined or oblique surface of an object will not appear true size on any of the normal planes or projection as shown in Figure 6-1. Only the edge view of

an inclined surface will appear true length if it is parallel to the projection plane.

### AUXILIARY VIEWS

An additional plane of projection must be placed parallel to the inclined surface (Figure 6-2) to obtain a true size drawing of an inclined surface. The projection

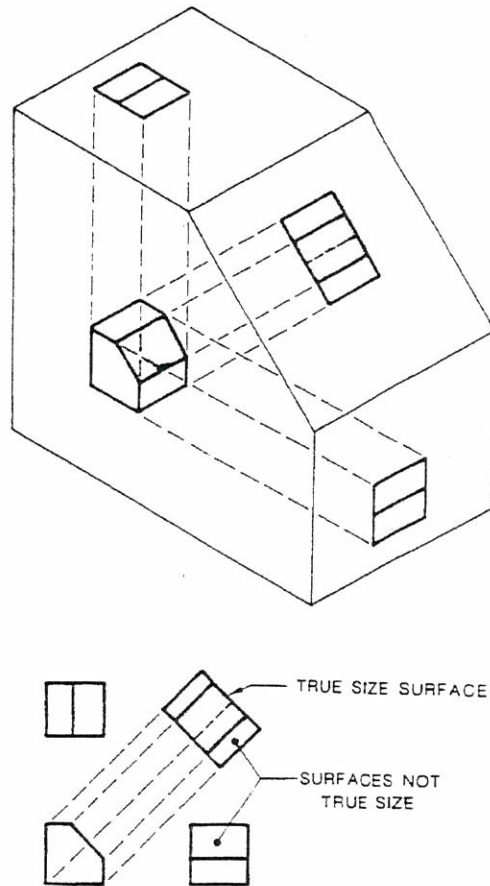
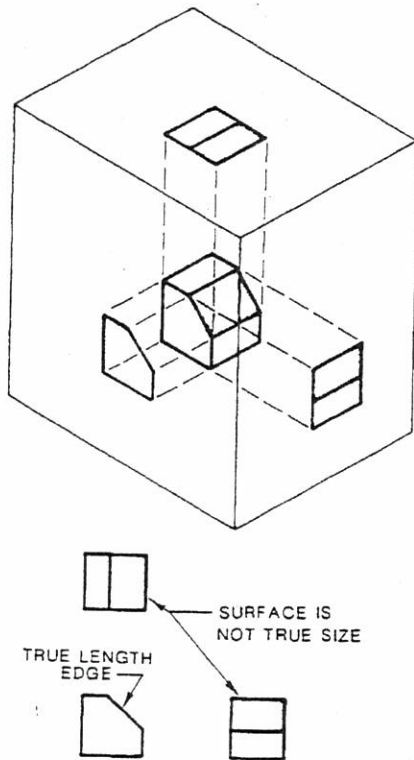

**Figure 6-1** An inclined surface will not appear true size on a normal projection plane.

**Figure 6-2** An inclined surface may appear true size on an auxiliary plane.

lines from the inclined surface to the auxiliary plane must be 90 degrees (perpendicular). The inclined surface in the auxiliary view will be true size, but any surface not parallel to the auxiliary plane will not be true size on the auxiliary view.

An auxiliary view may be projected from any view and at any angle. Figure 6-3A, B and C depict several types of auxiliary views. Note that the auxiliary drawing may be a full auxiliary showing the whole object, or a partial auxiliary showing only the true size of the auxiliary view's surface. All these views are called *primary auxiliary views*. For oblique surfaces it will be necessary to project another auxiliary view from the primary auxiliary. This is called a *secondary auxiliary view*. It is then possible to draw a tertiary view and so forth. For further information refer to advanced engineering drawing and descriptive geometry textbooks.

**Complete exercises 1 through 5**

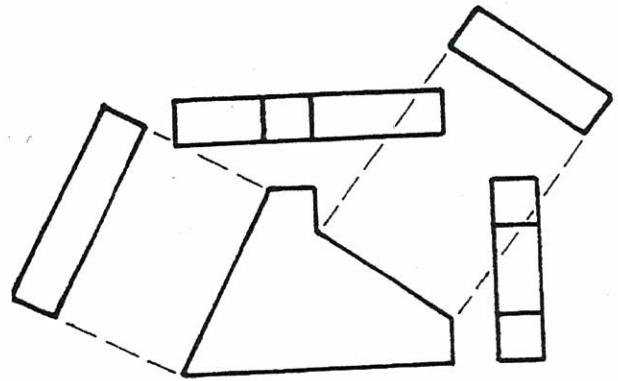

**Figure 6-3A** Two front partial auxiliary views.

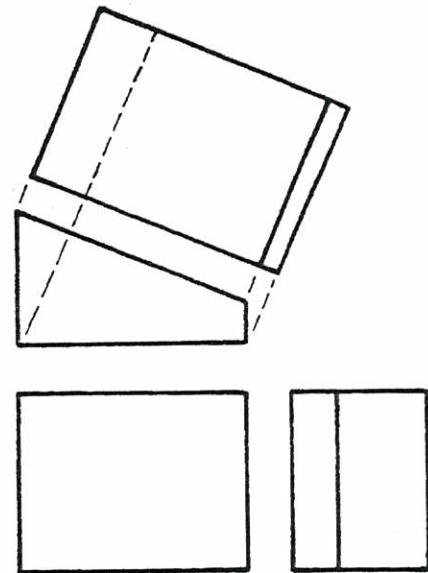

**Figure 6-3B** Full top view auxiliary drawing.

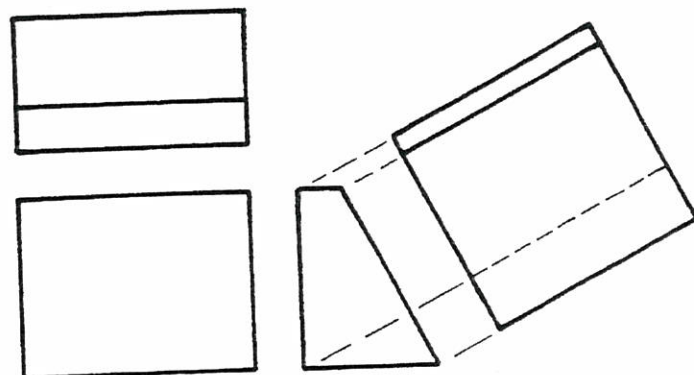

**Figure 6-3C** Full side view auxiliary drawing.

SLIDE BASE

Sketch auxiliary view showing true size of surface A only.

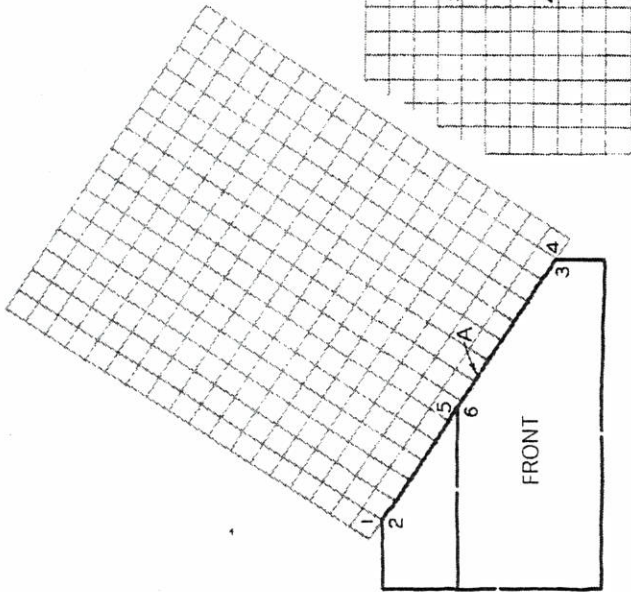

THIS IS A \_\_\_\_\_ AUXILIARY VIEW

WEDGE BLOCK

Sketch complete auxiliary view showing true size of surface C.

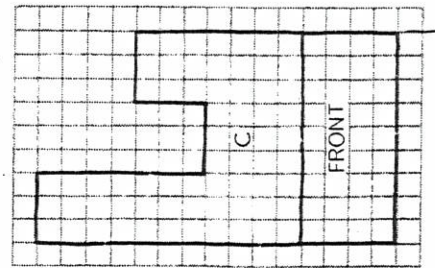

THIS IS A \_\_\_\_\_ AUXILIARY VIEW

ANGLE STOP

Sketch auxiliary view showing true size of surface B only.

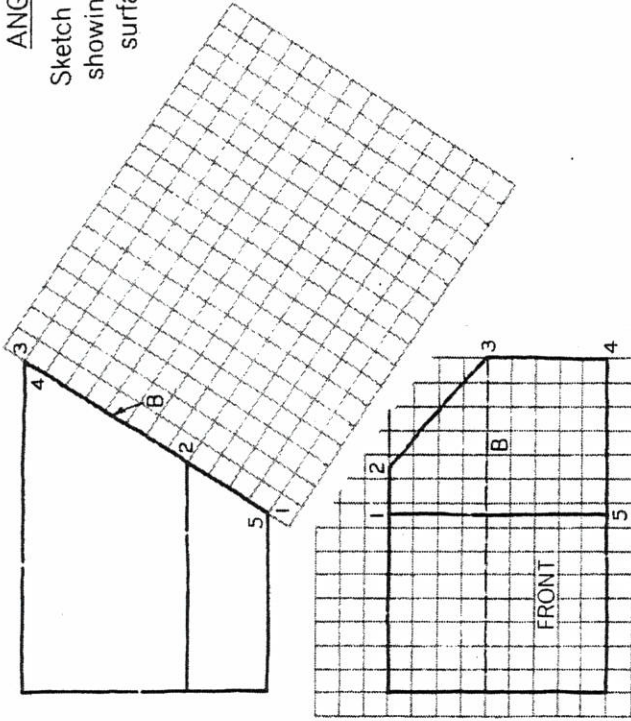

THIS IS A \_\_\_\_\_ AUXILIARY VIEW

HOLDER SLIDE

Sketch complete auxiliary view showing true size of surface D.

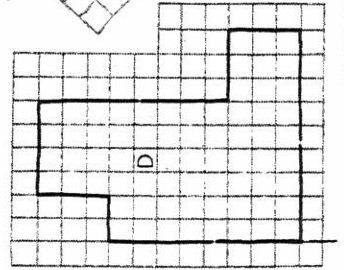

THIS IS A \_\_\_\_\_ AUXILIARY VIEW

**Problem 7-1:** Sketch or draw the auxiliary view of the inclined surfaces in parts A through D.

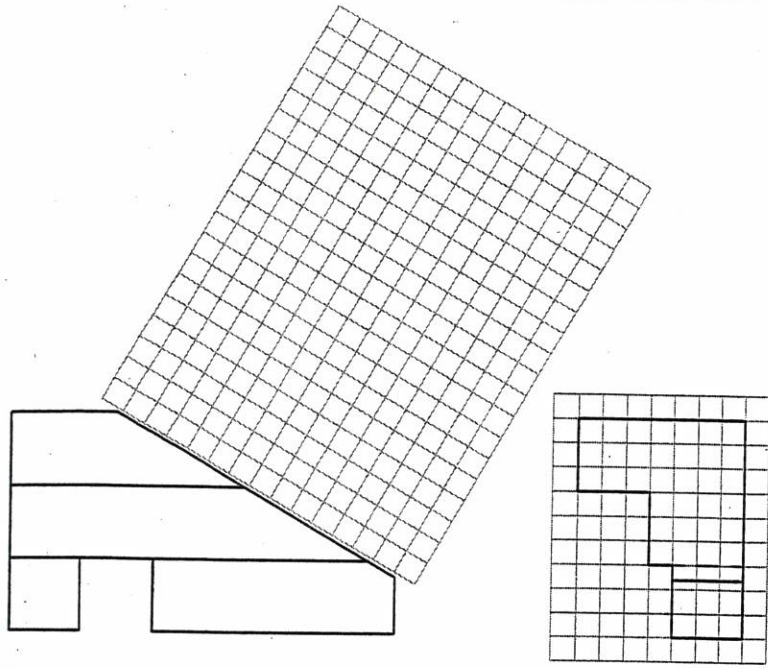

A

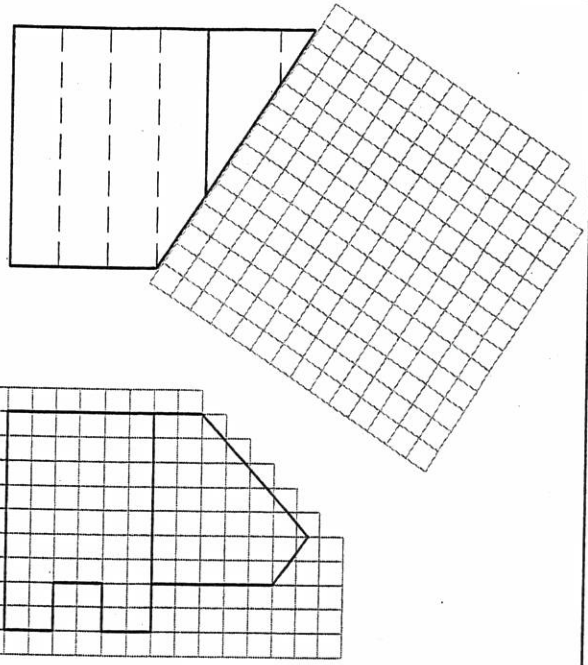

B

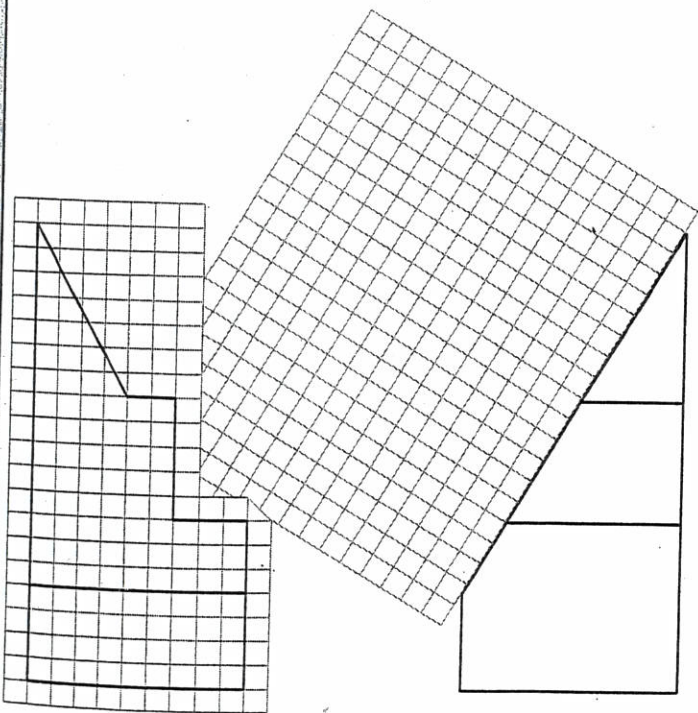

C

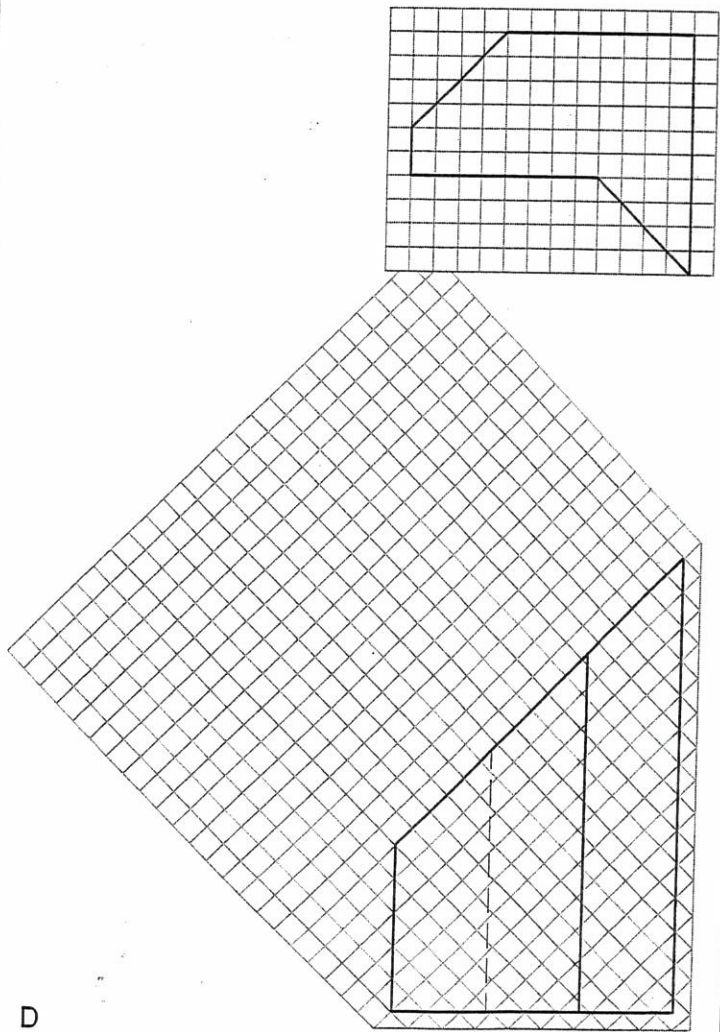

D

Instructions: Complete the full auxiliary view.

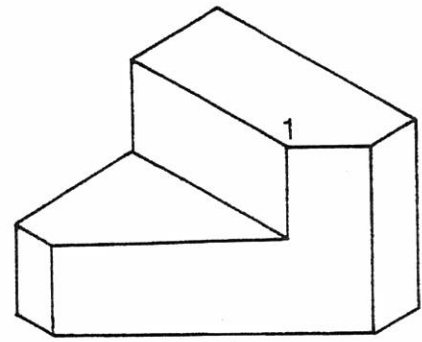
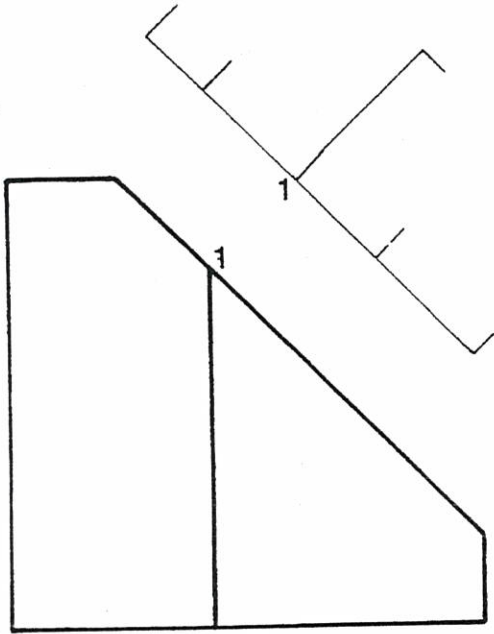
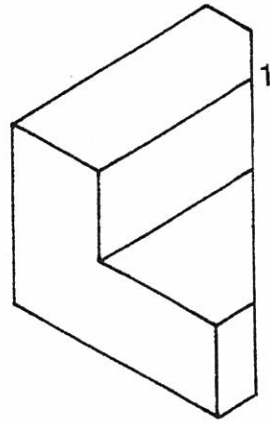

AUXILIARY VIEW

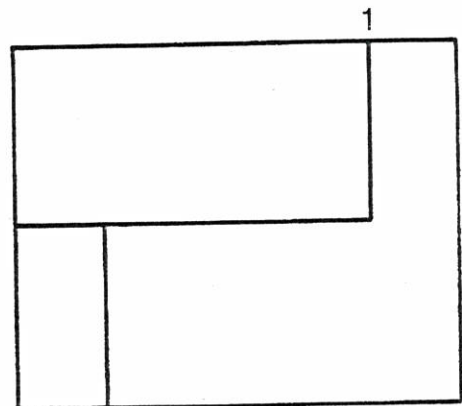
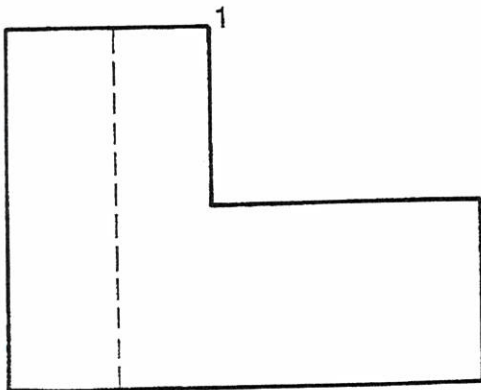

NAME:	TITLE: STEP WEDGE BLOCK	DRWG NO:
SCHOOL:	SCALE: 1:1	DATE:
		PERIOD:

Instructions: Complete the full auxiliary view.

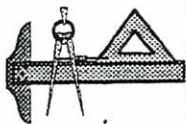
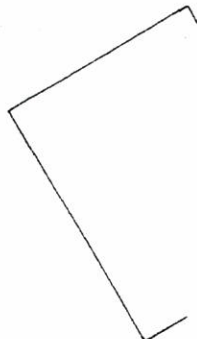
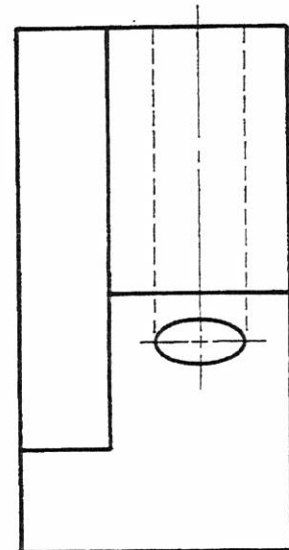
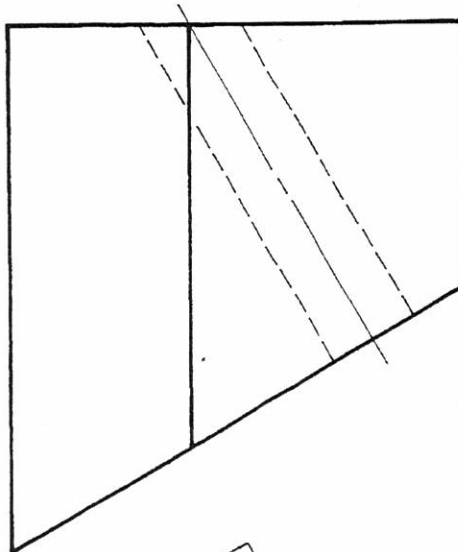
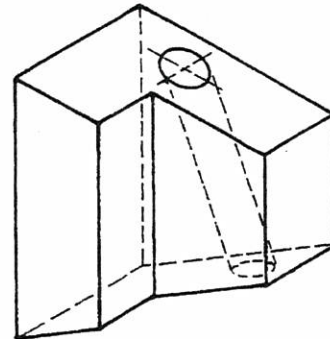
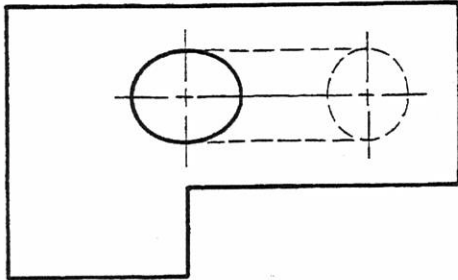

NAME: _____	TITLE: _____	DRWG NO: _____
SCHOOL: _____	SCALE: _____	DATE: _____
		PERIOD: _____

Instructions: Complete a partial or full auxiliary view for each exercise.

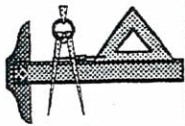
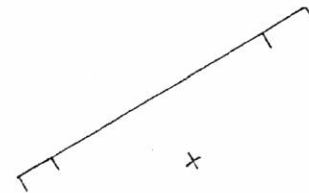
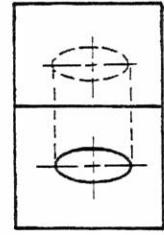
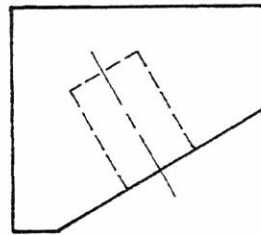
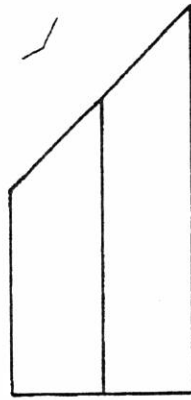
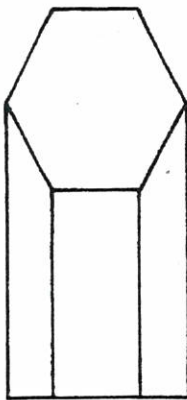
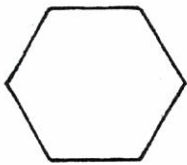
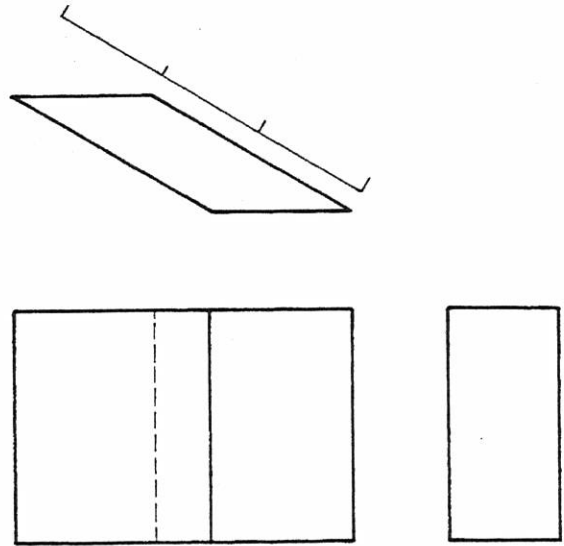
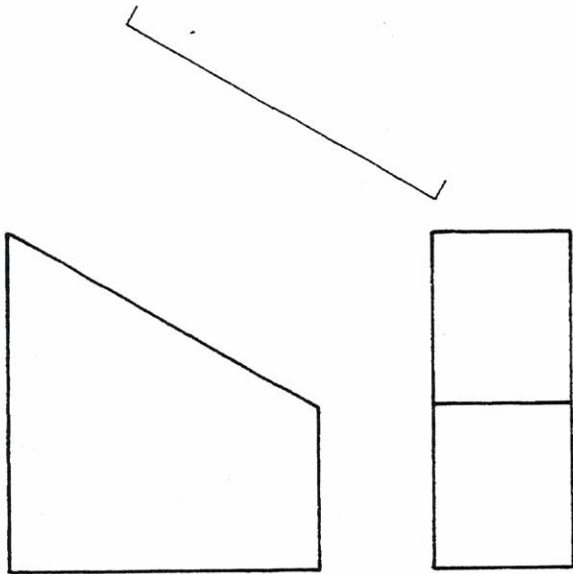

NAME: \_\_\_\_\_

TITLE: \_\_\_\_\_

DRWG NO: \_\_\_\_\_

SCHOOL: \_\_\_\_\_

SCALE: 1:1 DATE: \_\_\_\_\_

PERIOD: \_\_\_\_\_

Instructions: Complete the full auxiliary view.

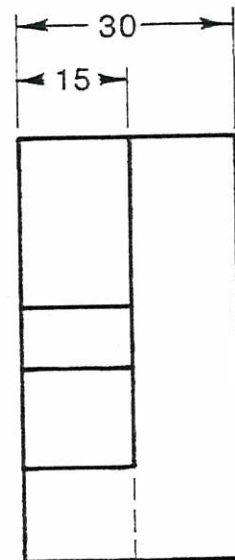
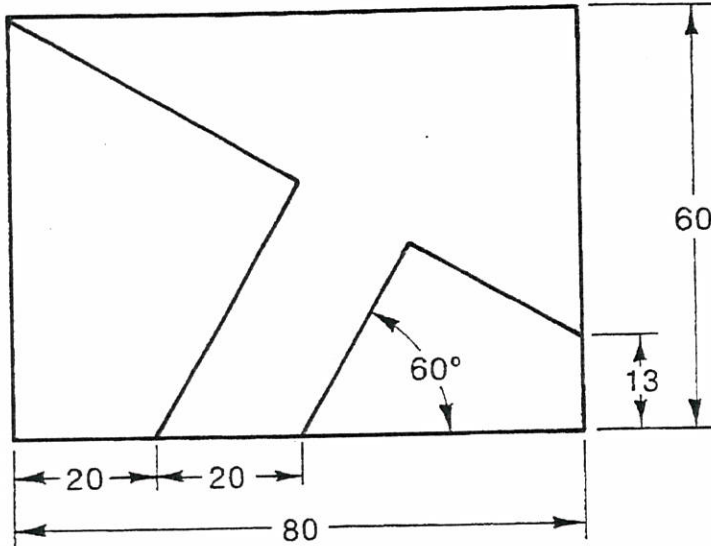
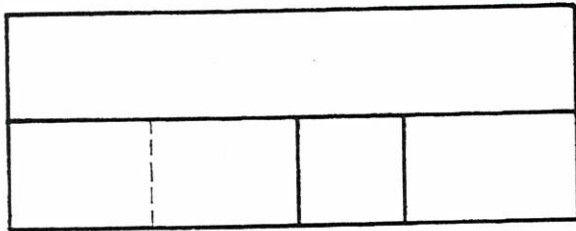
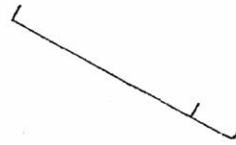
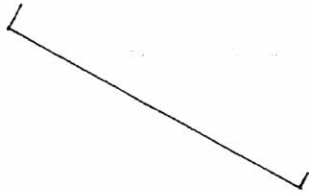
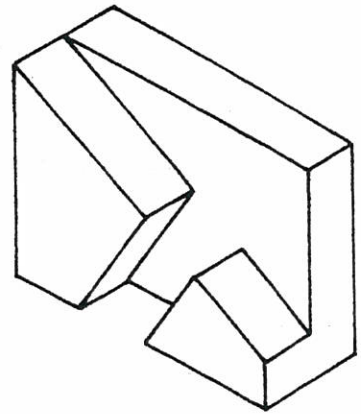

METRIC



NAME: _____	TITLE: JIG SLIDE LOCK	DRWG NO: _____
SCHOOL: _____	SCALE: 1:1	DATE: _____
		PERIOD: _____



Instructions: Complete the partial auxiliary view.

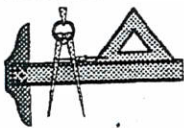
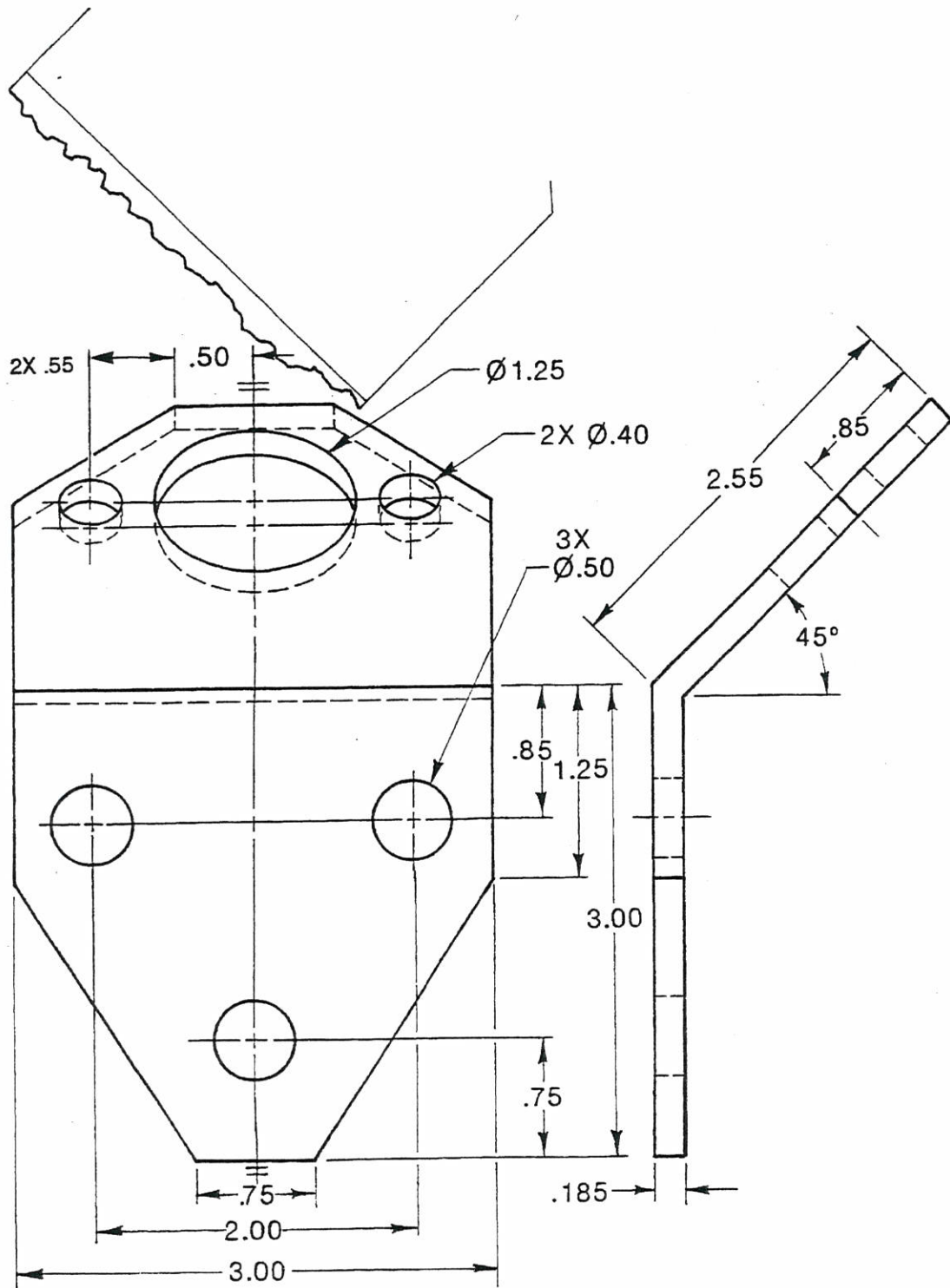

NAME:	TITLE: ANGLE BRACKET	DRWG NO:
SCHOOL:	SCALE: 1:1	DATE:
		PERIOD:

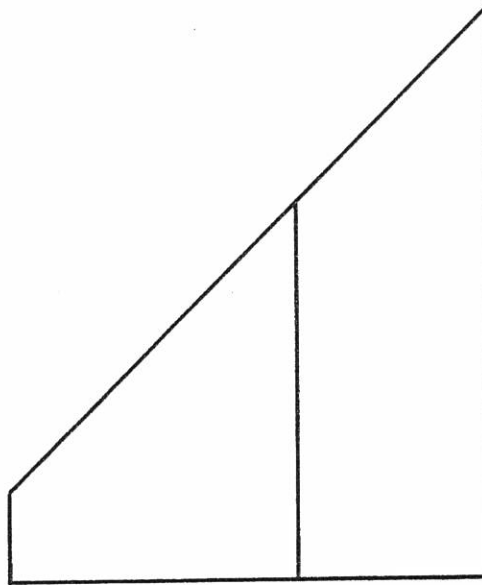
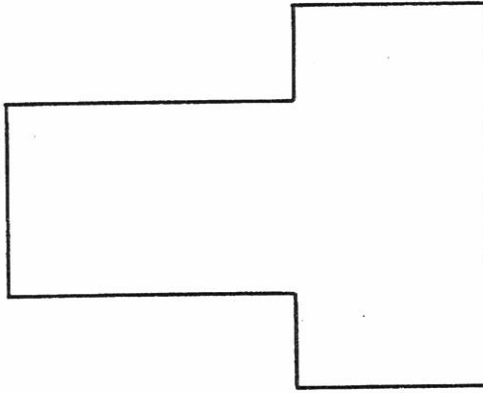

PROBLEM - DRAW AUXILIARY VIEW

11-2

TITLE: NOTCHED BLOCK

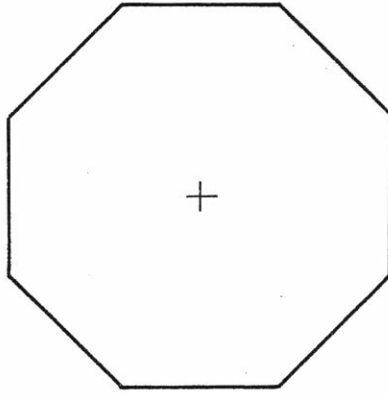
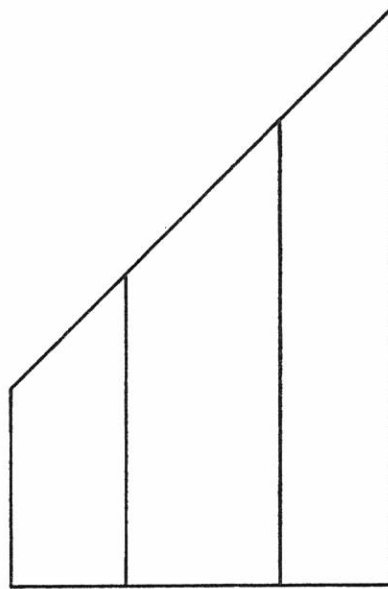

PROBLEM - DRAW AUXILIARY VIEW

11-4

TITLE: TRUNCATED OCTAGON

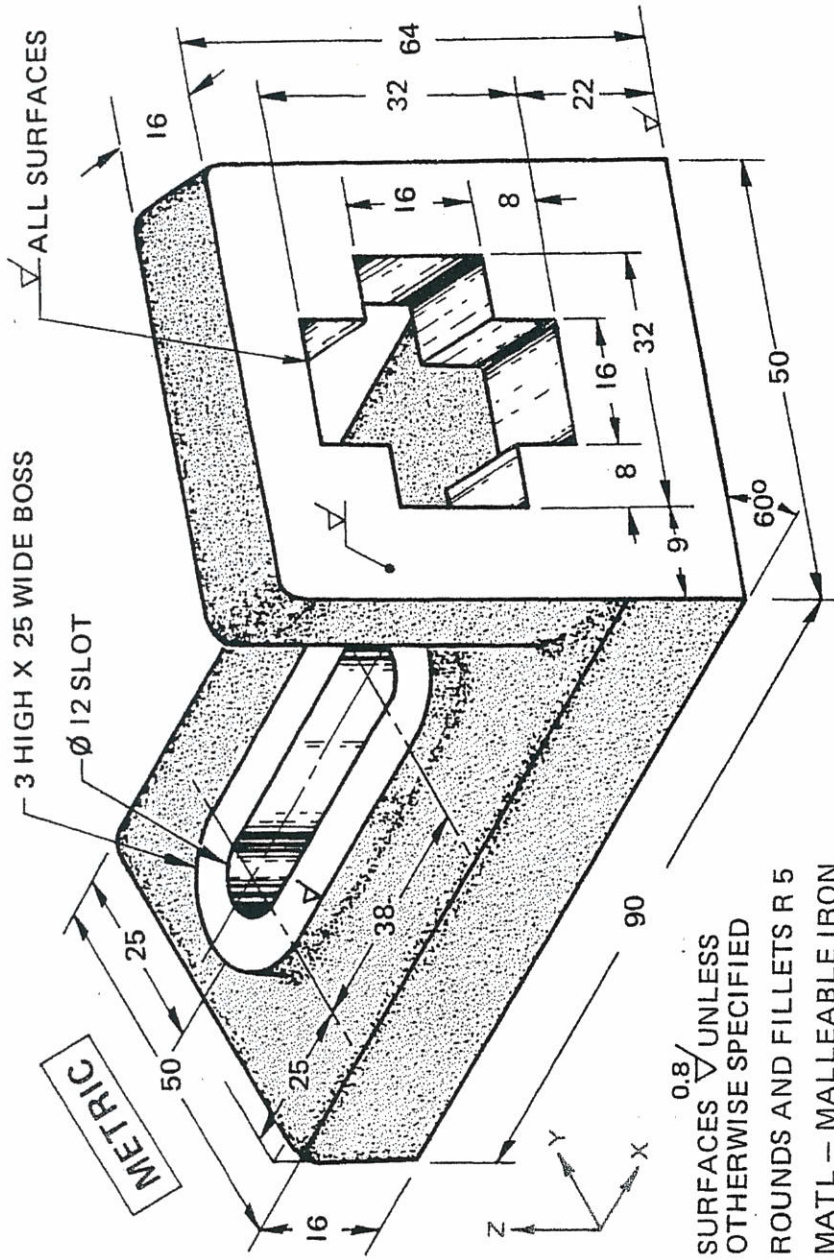

0.8/  
 SURFACES  $\nabla$  UNLESS  
 OTHERWISE SPECIFIED  
 ROUNDS AND FILLETS R 5  
 MATL - MALLEABLE IRON

ss-slide bracket.